

**STARKBAU**

ALUMINYUM PROFİL SİSTEMLERİ

[www.starkbau.com](http://www.starkbau.com)

**STARKBAU**

ALUMINYUM PROFİL SİSTEMLERİ

**SBW 65 (1,6 mm)**





























**ISI YALITIMLI DOĞRAMA SİSTEMİ**























STARKBAU bir ALPSAN tescilli markasıdır.

Bağış Mah. Kocuyolu Cad. 180/4. Sk. No: 3 41400 Gebze - Kocaeli Tel: 0 262 642 84 42 Faks: 0 262 642 84 41





NO	PROFİL ŞEKLİ	KALIP NO	PROFİL ADI	AĞIRLIK (kg/mt)	SAYFA NO
1		65010	ÇİFT KANAT ADAPTÖR PROFİLİ - 1.6 mm	1,227	7
2		65014	İÇE-ÇİFT KANAT ADAPTÖR PROFİLİ - 1.6 mm	0,837	8
3		65015	DIŞA AÇILIM ADAPTÖR PROFİLİ - 1.6 mm	1,003	9
4		65016	DIŞA-ÇİFT KANAT ADAPTÖR PROFİLİ - 1.6 mm	0,970	9
5		65100	KASA-ORTA KAYIT PROFİLİ - 1.6 mm	1,280	5
6		65101	KASA-ORTA KAYIT PROFİLİ - 1.6 mm	1,280	5
7		65102	L KASA PROFİLİ - 1.6 mm	1,159	5
8		65103	L KASA PROFİLİ - 1.6 mm	1,159	5
9		65104	KASA-ORTA KAYIT PROFİLİ - 1.6 mm	1,540	6
10		65105	KASA-ORTA KAYIT PROFİLİ - 1.6 mm	1,540	6
11		65106	Z KASA PROFİLİ - 1.6 mm	1,269	6
12		65107	Z KASA PROFİLİ - 1.6 mm	1,269	6
13		65108	KANAT PROFİLİ - 1.6 mm	1,365	7
14		65109	GENİŞ KANAT PROFİLİ (ÇEK-SÜR) - 1.6 mm	1,487	7
15		65110	GENİŞ KANAT PROFİLİ (KATLANIR) - 1.6 mm	1,868	7
16		65111	İÇE-DIŞA KANAT PROFİLİ - 1.6 mm	1,576	9
17		65112	İÇE-DIŞA KANAT PROFİLİ - 1.6 mm	1,569	9
18		65113	ALT ETEK PROFİLİ - 1.6 mm	2,182	10
19		5714	CAM ÇITASI	0,367	8
20		5715	CAM ÇITASI	0,348	8
21		5716	CAM ÇITASI	0,322	8
22		5717	CAM ÇITASI	0,309	8
23		5718	CAM ÇITASI	0,275	8
24		5719	CAM TAKOZU	0,208	8
25		5720	DAMLALIK	0,158	8
26		5725	İÇE AÇILIM ADAPTÖR PROFİLİ (DIŞ)	0,273	9
27		5734	EŞİK PROFİLİ	0,800	10
28		5735	EŞİK PROFİLİ	0,083	10
29		5736	KÖŞE TAKOZU	5,335	11

NO	PROFİL ŞEKLİ	KALIP NO	PROFİL ADI	AĞIRLIK (kg/mt)	SAYFA NO
30		5737	KÖŞE TAKOZU	5,097	11
31		5738	KÖŞE TAKOZU	6,377	11
32		5739	KÖŞE TAKOZU	6,848	13
33		5740	KÖŞE TAKOZU	8,178	13
34		5741	KÖŞE TAKOZU	3.121	12
35		5742	U ÇEKTİRME PROFİLİ	0.916	12
36		5743	U ÇEKTİRME PROFİLİ	0.616	12
37		5744	DIŞ PERVAZ	0.252	12
38		5745	İÇ PERVAZ	0.309	12
39		5746	EŞİK PROFİLİ	0.293	12
40		4400	EPDM FİTİL	0,057	13
41		4401	EPDM FİTİL	0,036	13
42		4403	EPDM FİTİL	0,038	13
43		4404	EPDM FİTİL	0.054	13
44		4405	EPDM FİTİL	0.131	13
45		DP-1	PLASTİKLER		15
46		DP-2	PLASTİKLER		15
47		DP-3	PLASTİKLER		15
48		DP-4	PLASTİKLER		15
49		DP-5	PLASTİKLER		15
50		DP-6	PLASTİKLER		15
51		DP-7	TAHLİYE KAPAĞI		12
52		DA-5	KÖŞE ÇAVUŞU		11

SBW 65 (1,6 mm) PROFİLLERİ VE AKSESUARLARI



STARKBAU  
ALÜMİNYUM PROFİL SİSTEMLERİ

STARKBAU  
ALÜMİNYUM PROFİL SİSTEMLERİ

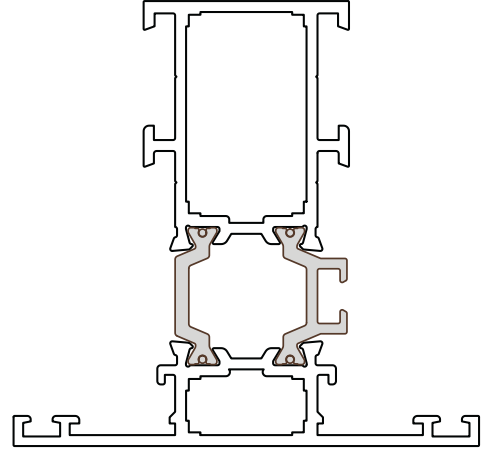
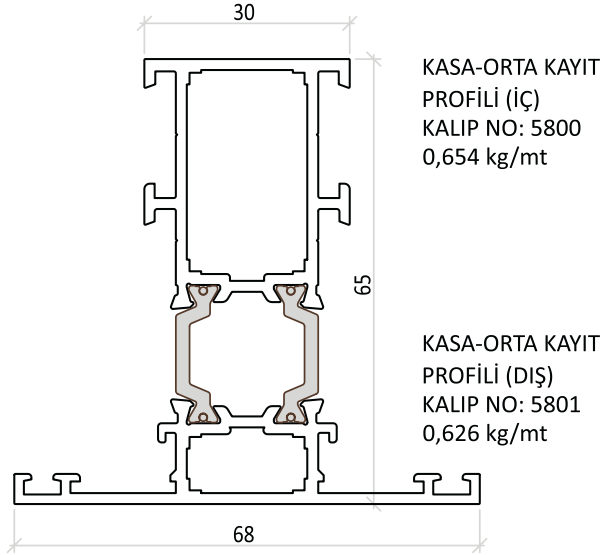

KASA-ORTA KAYIT PROFİLİ  
KALIP NO 65100  
1,280 kg/mt  
Jx: 25,90 cm<sup>4</sup>  
Jy: 8,87 cm<sup>4</sup>

KASA-ORTA KAYIT PROFİLİ  
KALIP NO 65101  
1,280 kg/mt  
Jx: 25,90 cm<sup>4</sup>  
Jy: 8,87 cm<sup>4</sup>

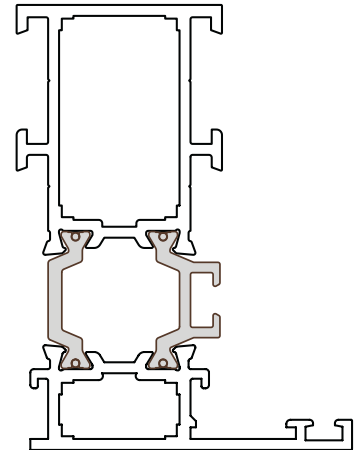
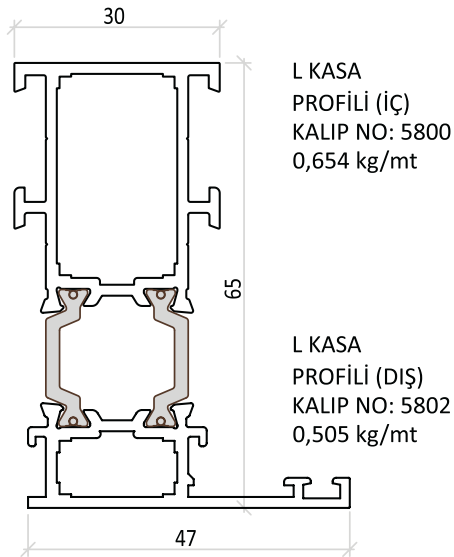

L KASA PROFİLİ  
KALIP NO 65102  
1,159 kg/mt  
Jx: 23,26 cm<sup>4</sup>  
Jy: 5,18 cm<sup>4</sup>

L KASA PROFİLİ  
KALIP NO 65103  
1,159 kg/mt  
Jx: 23,26 cm<sup>4</sup>  
Jy: 5,18 cm<sup>4</sup>

SBW 65 (1,6 mm) / PROFİLLER - AKSESUARLAR

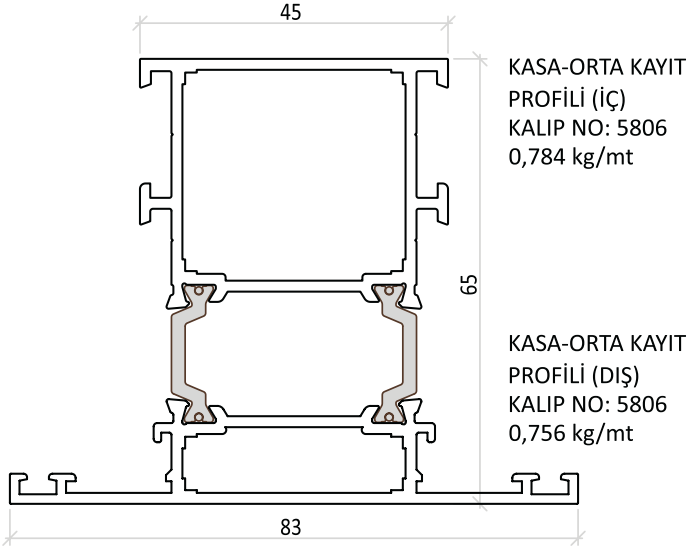

KASA-ORTA KAYIT PROFİLİ  
KALIP NO 65104  
1,540 kg/mt  
Jx: 31,47 cm<sup>4</sup>  
Jy: 19,78 cm<sup>4</sup>

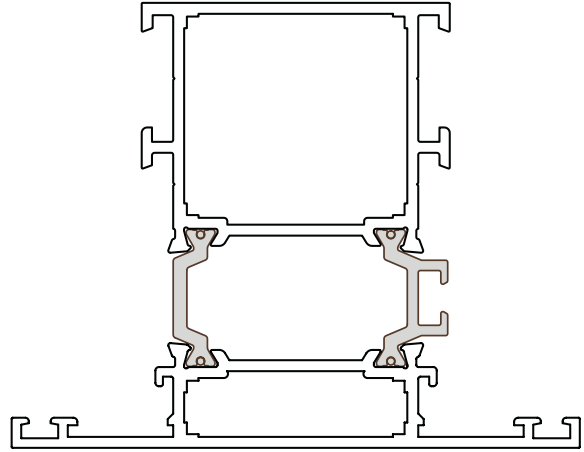

KASA-ORTA KAYIT PROFİLİ  
KALIP NO 65105  
1,540 kg/mt  
Jx: 31,47 cm<sup>4</sup>  
Jy: 19,78 cm<sup>4</sup>

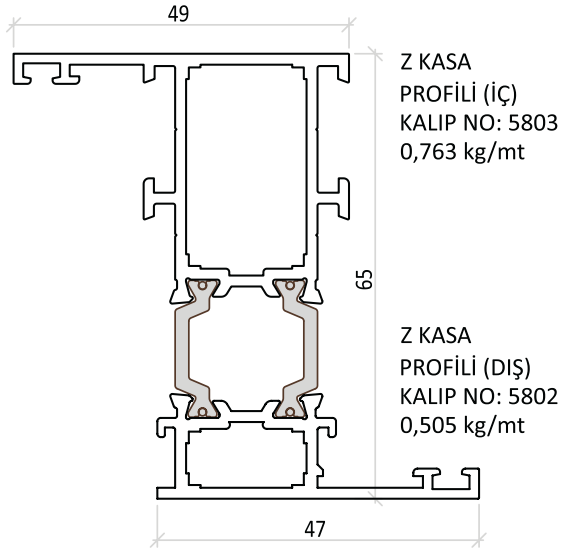

Z KASA PROFİLİ  
KALIP NO 65106  
1,269 kg/mt  
Jx: 29,07 cm<sup>4</sup>  
Jy: 6,63 cm<sup>4</sup>

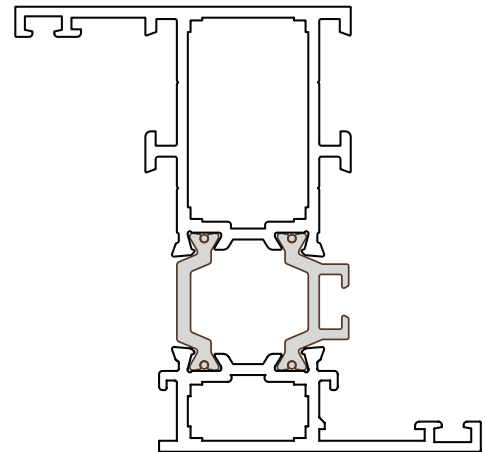

Z KASA PROFİLİ  
KALIP NO 65107  
1,269 kg/mt  
Jx: 29,07 cm<sup>4</sup>  
Jy: 6,63 cm<sup>4</sup>



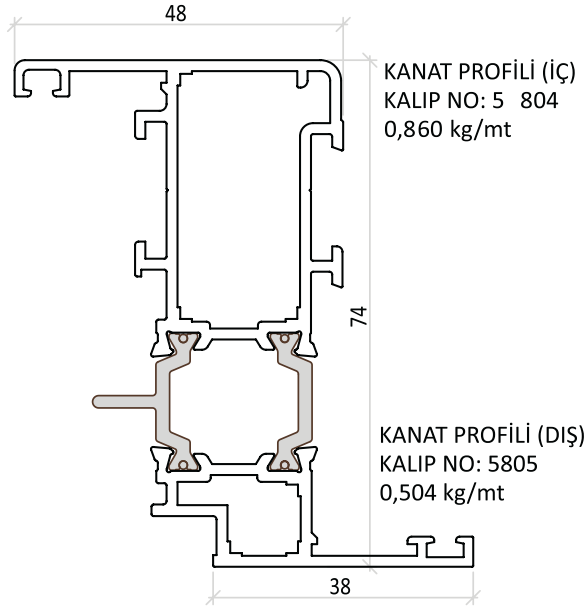

KANAT PROFİLİ  
KALIP NO 65108  
1,365 kg/mt  
Jx: 37,38 cm<sup>4</sup>  
Jy: 7,06 cm<sup>4</sup>

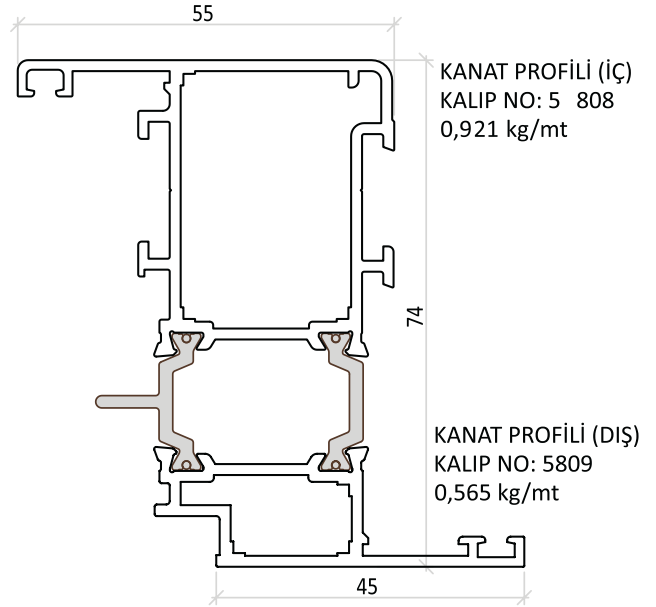

GENİŞ KANAT PROFİLİ (ÇEK-SÜR)  
KALIP NO 65109  
1,487 kg/mt  
Jx: 41,59 cm<sup>4</sup>  
Jy: 11,01 cm<sup>4</sup>

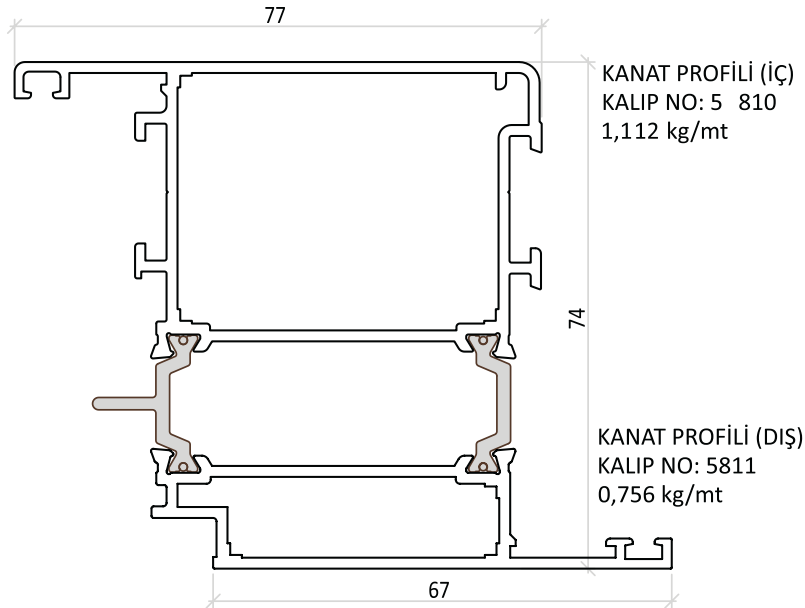

GENİŞ KANAT PROFİLİ(KATLANIR)  
KALIP NO 65110  
1,868 kg/mt  
Jx: 57,23 cm<sup>4</sup>  
Jy: 30,09 cm<sup>4</sup>

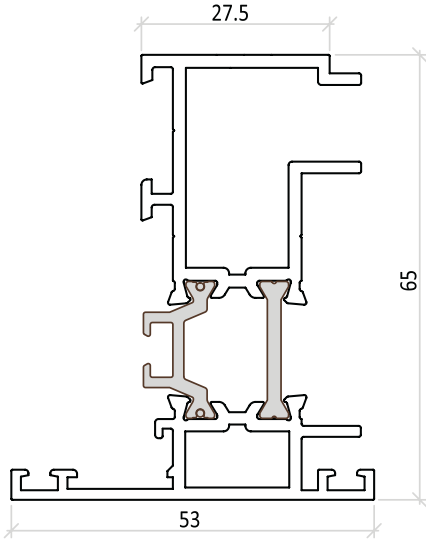

ÇİFT KANAT ADAPTÖR PROFİLİ (İÇ)  
KALIP NO: 5706  
0,648 kg/mt

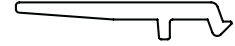

CAM TAKOZU  
KALIP NO: 5719  
0,208 kg/mt

ÇİFT KANAT ADAPTÖR PROFİLİ (DIŞ)  
KALIP NO: 5707  
0,578 kg/mt

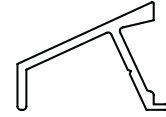

DAMLALIK  
KALIP NO: 5720  
0,158 kg/mt

ÇİFT KANAT ADAPTÖR PROFİLİ  
KALIP NO 65010  
1,227 kg/mt  
Jx: 24,24 cm<sup>4</sup>  
Jy: 5,89 cm<sup>4</sup>

#### CAM ÇİTALARI

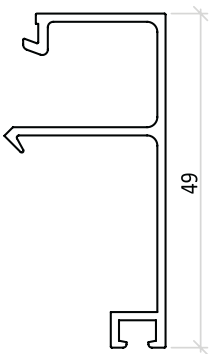

KALIP NO: 5714  
0,367 kg/mt

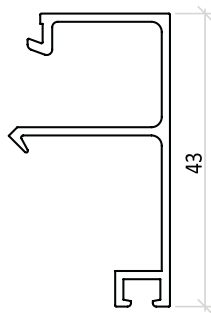

KALIP NO: 5715  
0,348 kg/mt

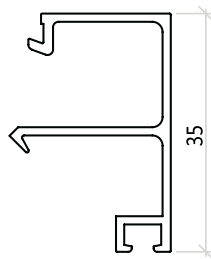

KALIP NO: 5716  
0,322 kg/mt

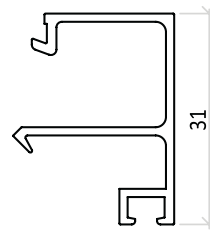

KALIP NO: 5717  
0,309 kg/mt

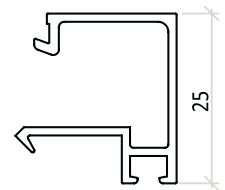

KALIP NO: 5718  
0,275 kg/mt

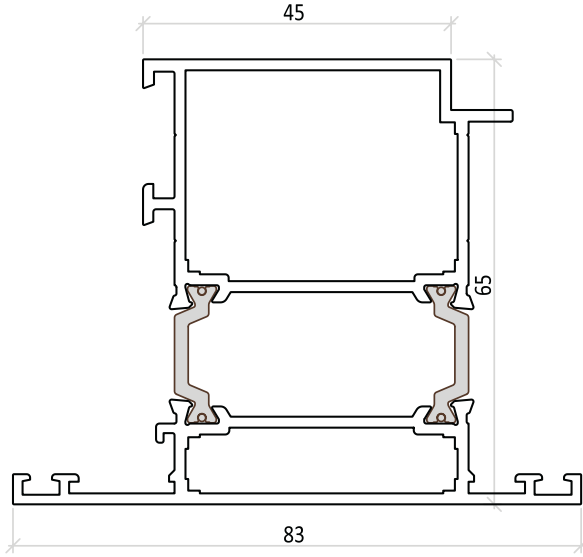

İÇE-DIŞA KANAT  
PROFİLİ (İÇ)  
KALIP NO: 5812  
0,802 kg/mt

İÇE-DIŞA KANAT  
PROFİLİ (DIŞ)  
KALIP NO: 5813  
0,774 kg/mt

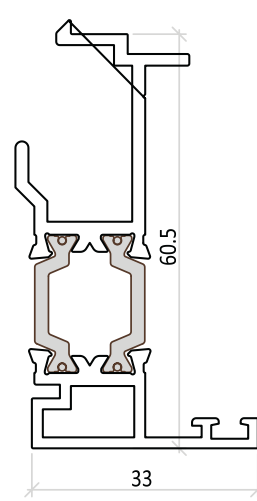

İÇE-ÇİFT KANAT  
ADAPTÖR PR. (İÇ)  
KALIP NO: 5726  
0,438 kg/mt

İÇE-ÇİFT KANAT  
ADAPTÖR PR. (DIŞ)  
KALIP NO: 5727  
0,398 kg/mt

İÇE-DIŞA KANAT PROFİLİ  
KALIP NO 65111  
1,576 kg/mt  
Jx: 31,77 cm<sup>4</sup>  
Jy: 23,14 cm<sup>4</sup>

İÇE-ÇİFT KANAT ADAPTÖR PROFİLİ  
KALIP NO 65014  
0,837 kg/mt  
Jx: 12,81 cm<sup>4</sup>  
Jy: 1,98 cm<sup>4</sup>

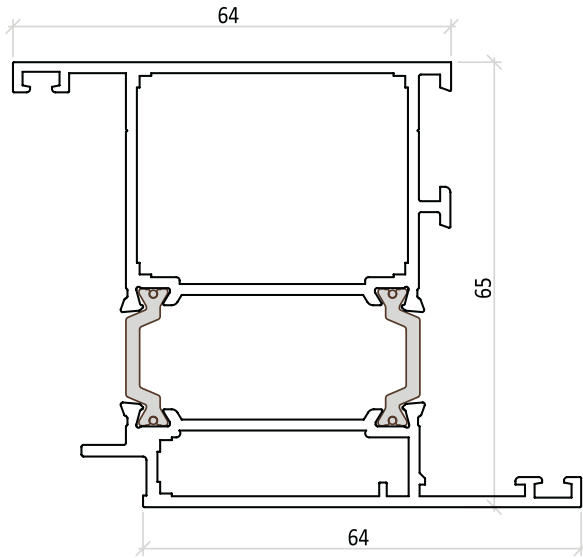

İÇE-DIŞA KANAT  
PROFİLİ (İÇ)  
KALIP NO: 5814  
0,871 kg/mt

İÇE-DIŞA KANAT  
PROFİLİ (DIŞ)  
KALIP NO: 5815  
0,697 kg/mt

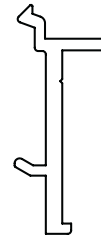

İÇE AÇILIM ADAPTÖR PROFİLİ (DIŞ)  
KALIP NO: 5725  
0,273 kg/mt

İÇE-DIŞA KANAT PROFİLİ  
KALIP NO 65112  
1,569 kg/mt  
Jx: 36,25 cm<sup>4</sup>  
Jy: 19,83 cm<sup>4</sup>

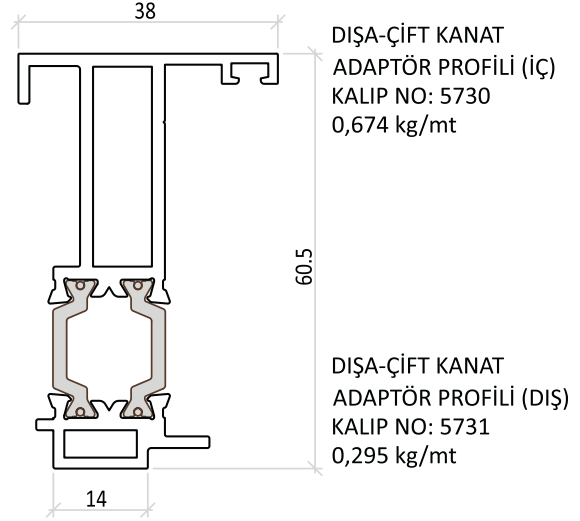
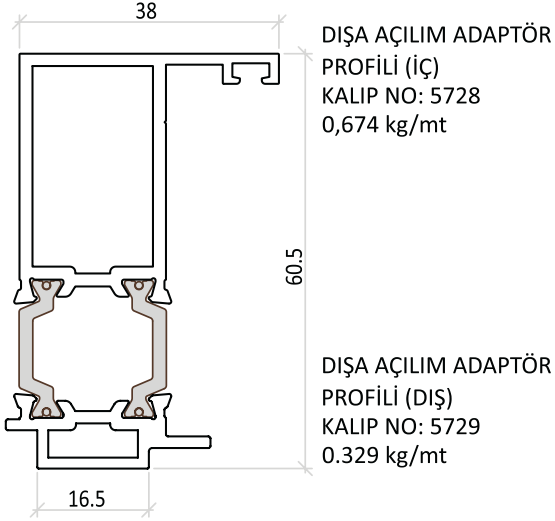

DIŞA AÇILIM ADAPTÖR PROFİLİ  
KALIP NO 65015  
1,003 kg/mt  
Jx: 17,11 cm<sup>4</sup>  
Jy: 3,38 cm<sup>4</sup>

DIŞA-ÇİFT KANAT ADAPTÖR PROFİLİ  
KALIP NO 65016  
0,970 kg/mt  
Jx: 16,67 cm<sup>4</sup>  
Jy: 2,17 cm<sup>4</sup>

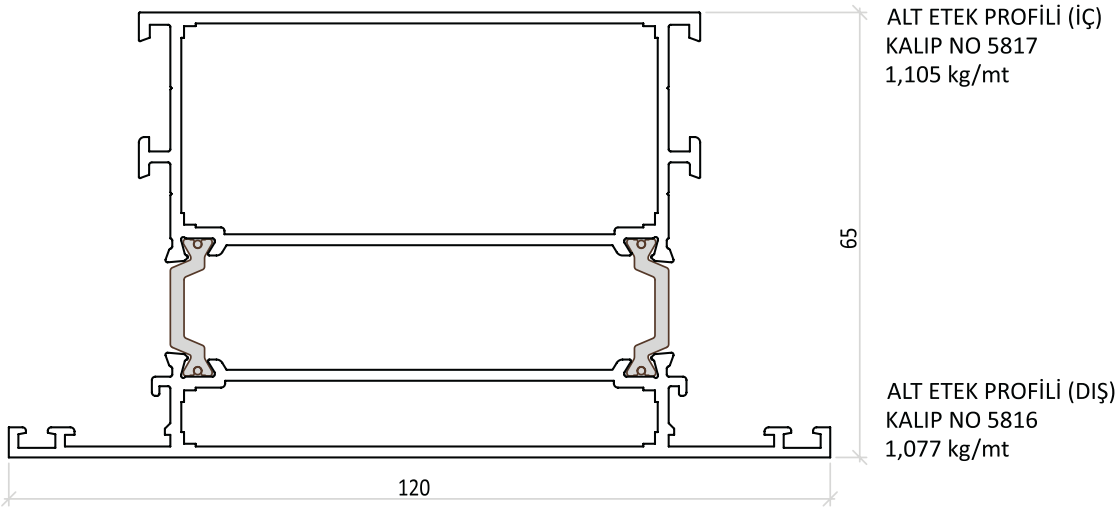

ALT ETEK PROFİLİ  
KALIP NO 65113  
2,182 kg/mt  
Jx: 76,33 cm<sup>4</sup>  
Jy: 45,20 cm<sup>4</sup>

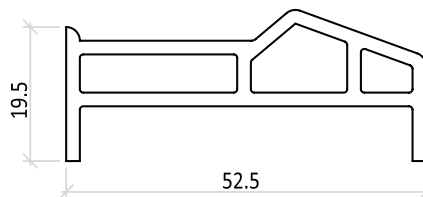

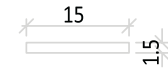
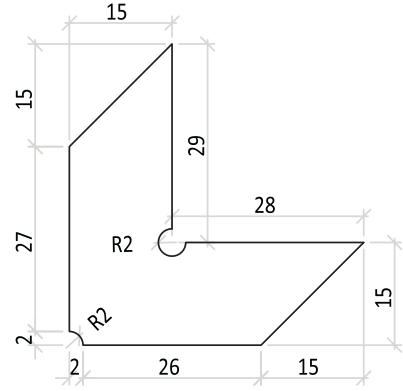
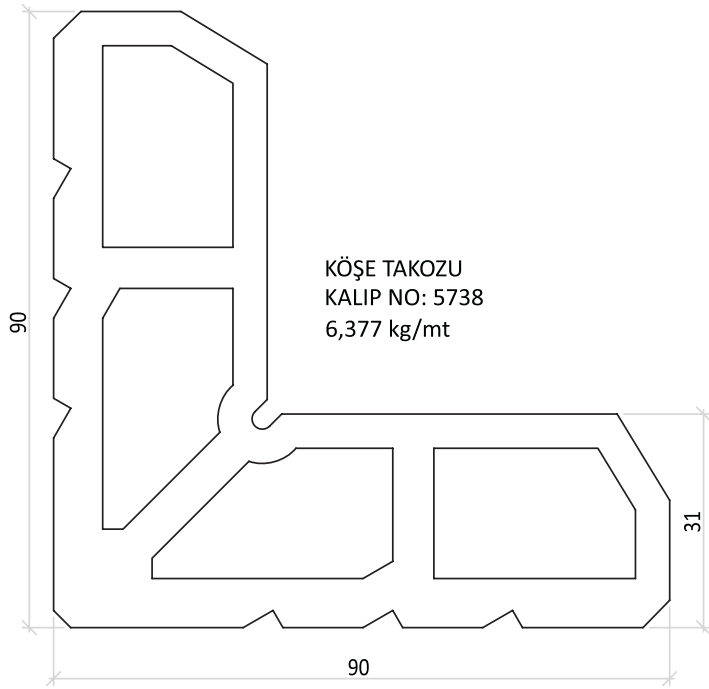
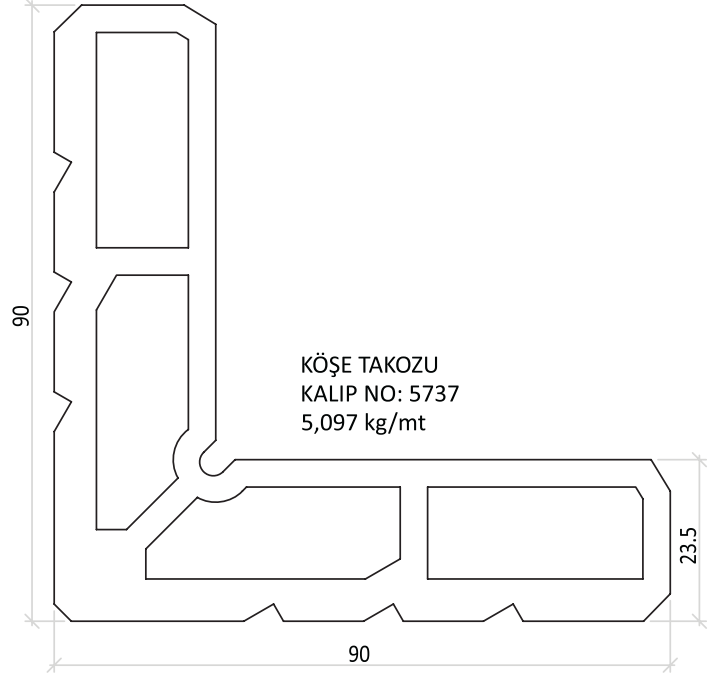
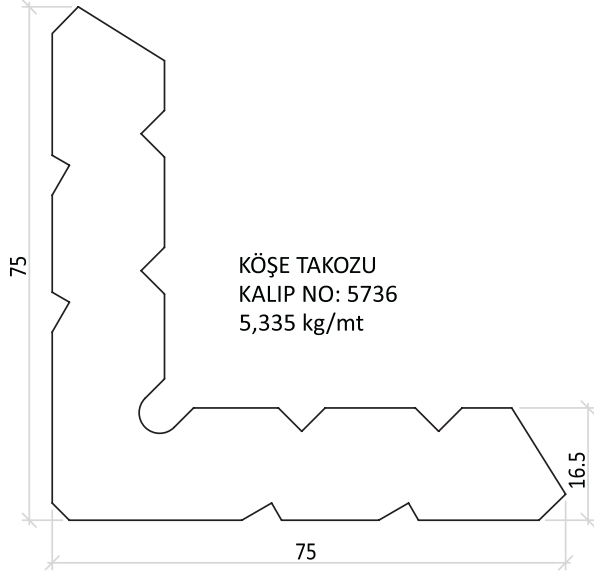

KÖŞE ÇAVUŞU  
DA-5

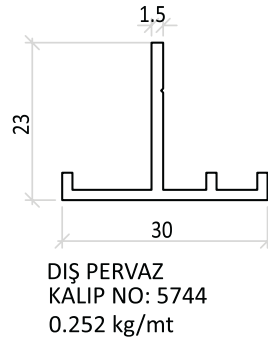
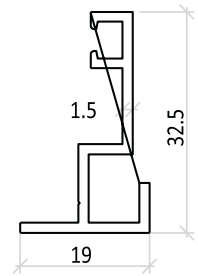
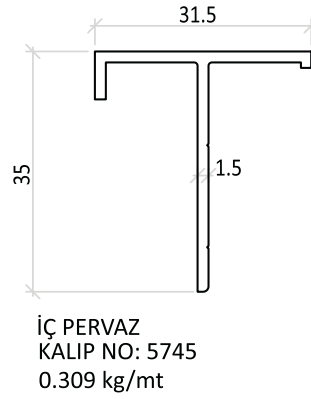
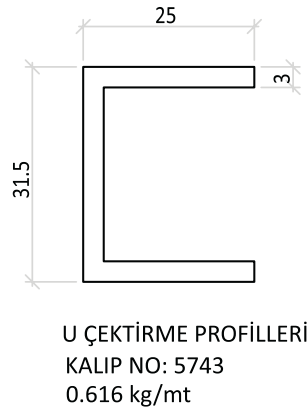
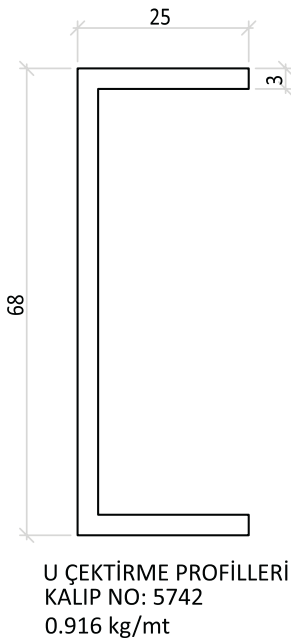
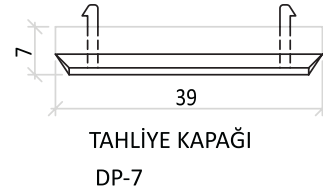
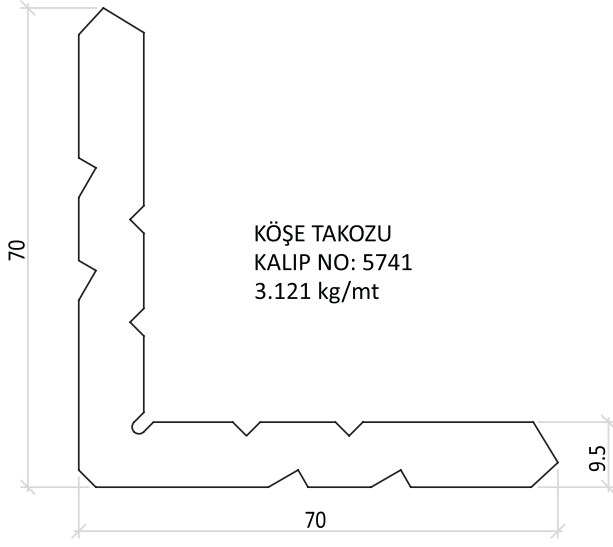

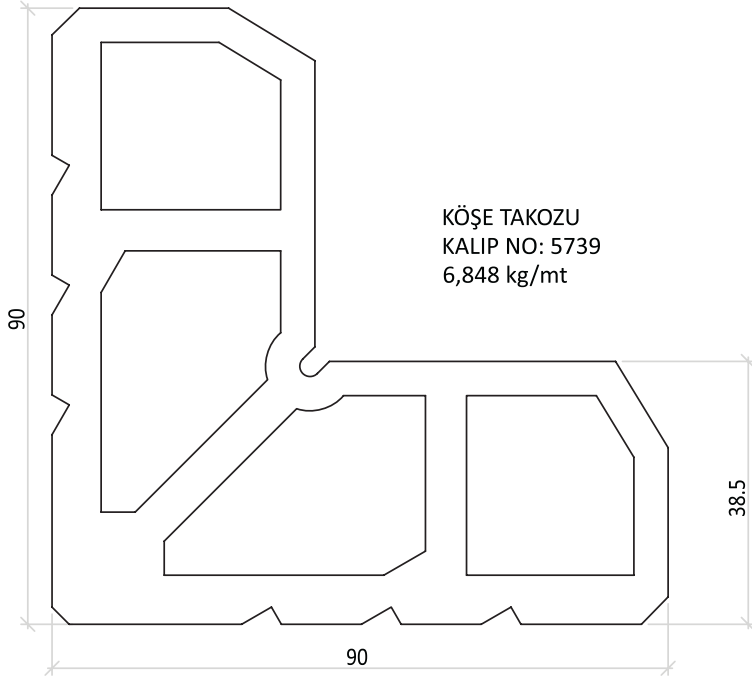

FİTİLLER



4400 EPDM FİTİL  
0,057 kg/mt



4401 EPDM FİTİL  
0,036 kg/mt



4403 EPDM FİTİL  
0,038 kg/mt



4404 EPDM FİTİL  
0.054 kg/mt

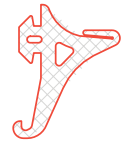

4405 EPDM FİTİL  
0.131 kg/mt

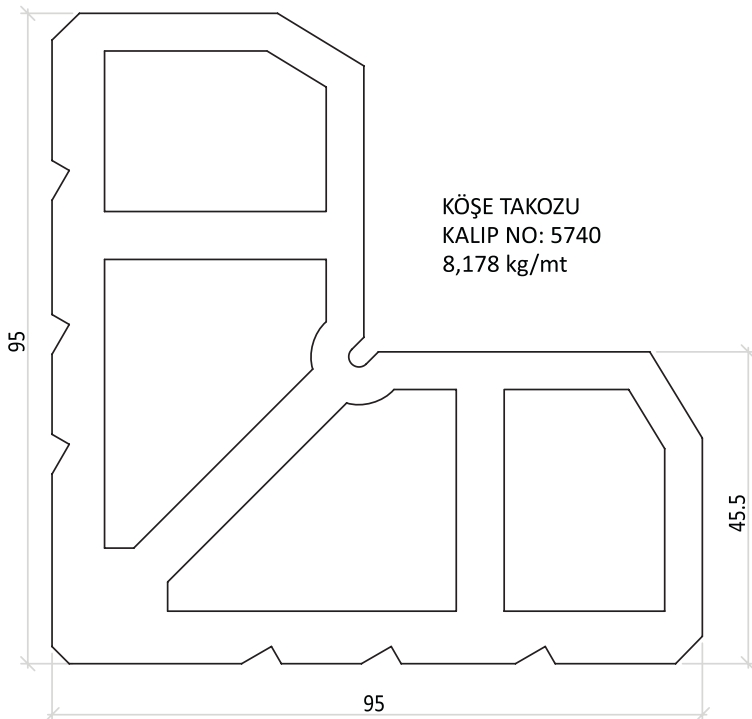

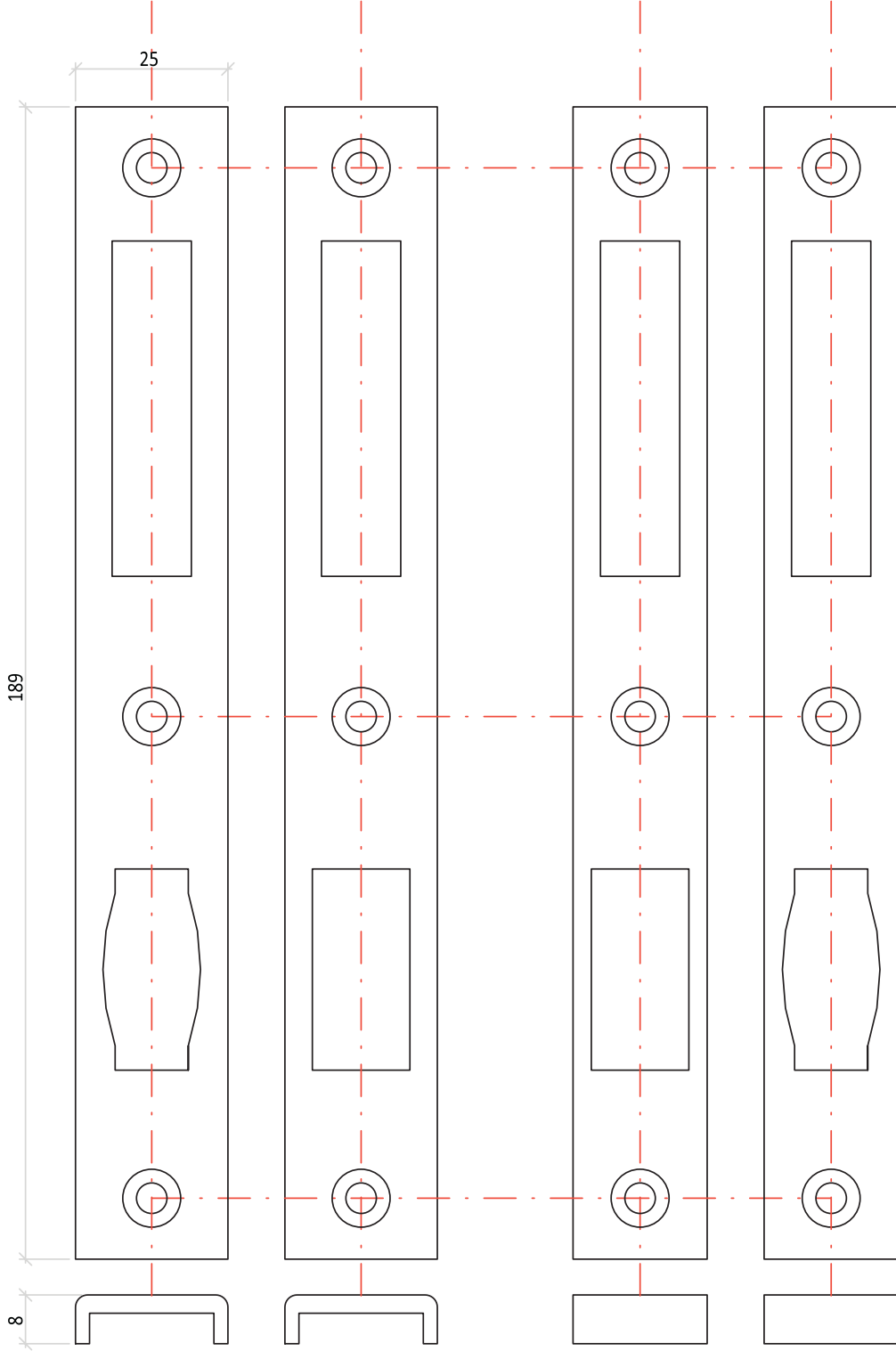

U KİLİT KARŞILIĞI

LAMA KİLİT KARŞILIĞI

KALIP NO: 5747

0.477 kg/mt



PLASTİKLER

DP-1

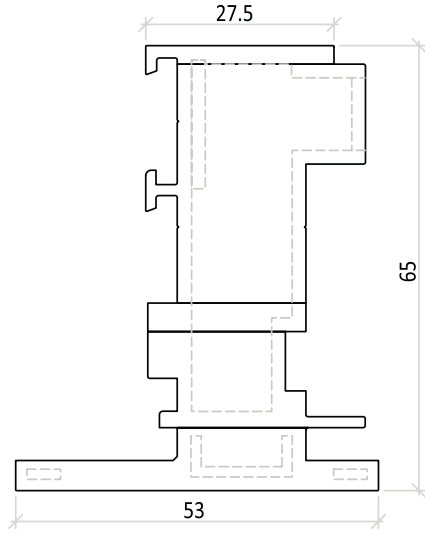

DP-2

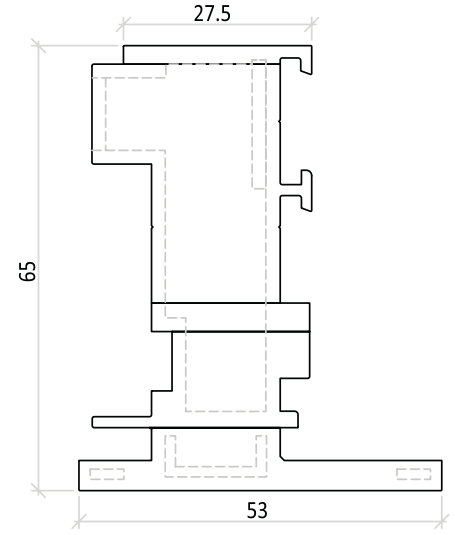

DP-3

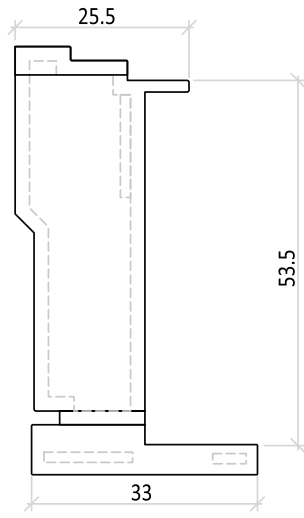

DP-4

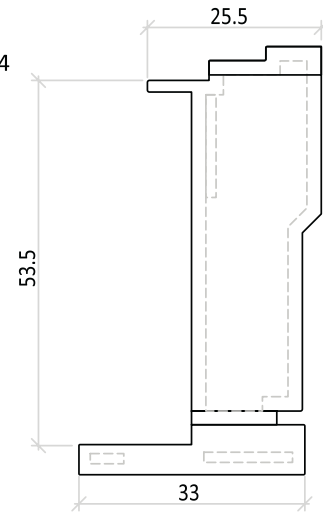

DP-5

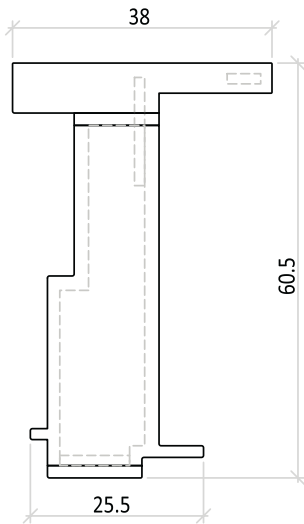

DP-6

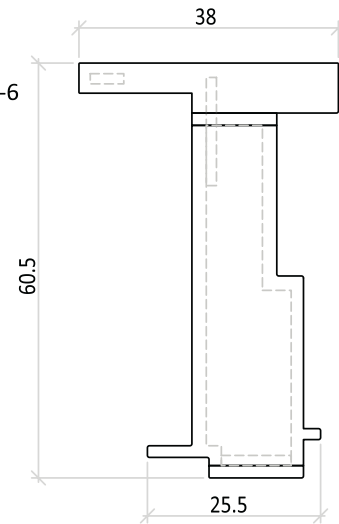

SBW 65 (1,6 mm) ADAPTÖRLÜ DIŐA AÇILIR SİSTEM DETAYI



**STARKBAU**  
ALÜMİNYUM PROFİL SİSTEMLERİ

DT-01

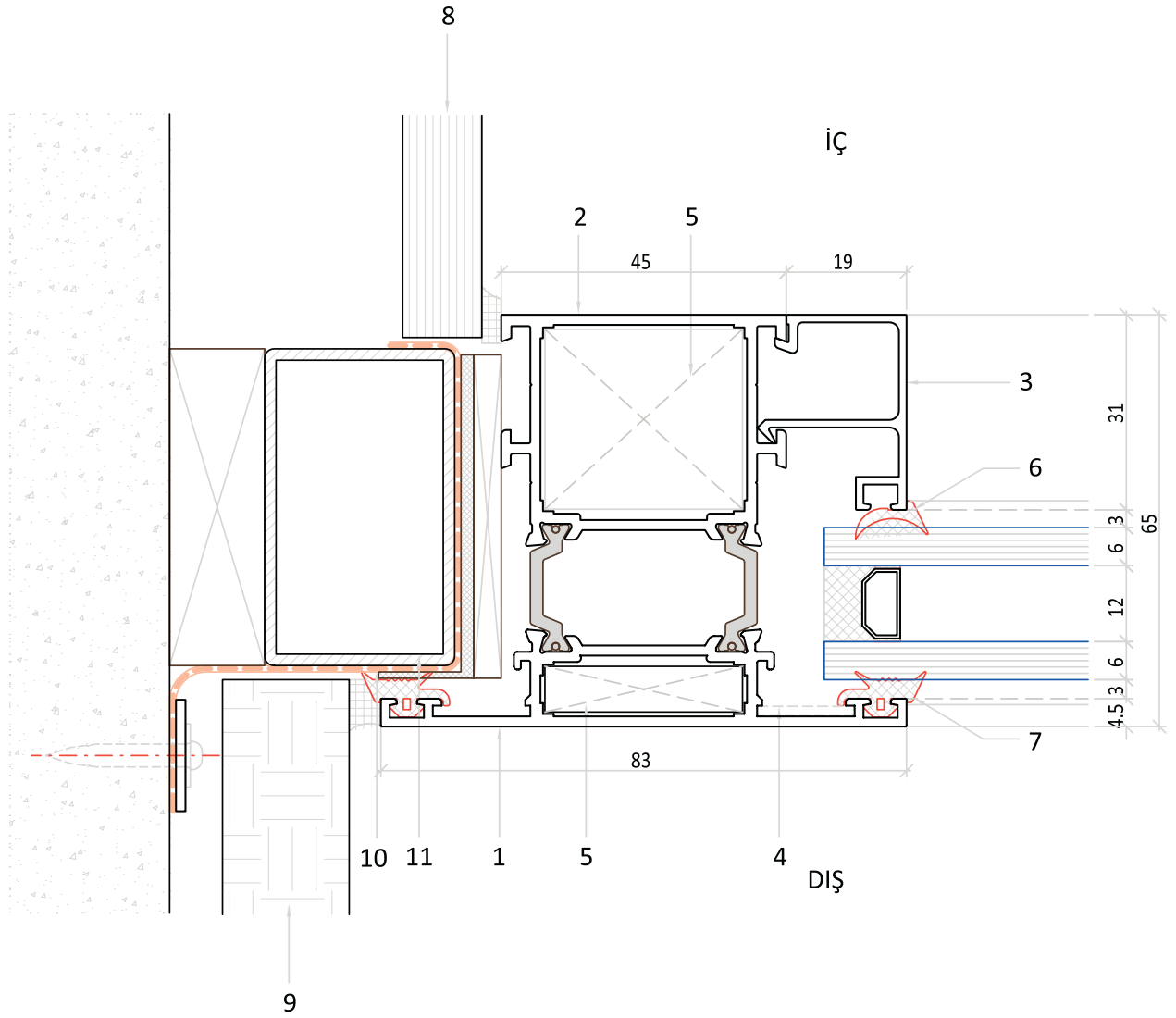

- 1 5807 KASA PROFİLİ (DIŞ)
- 2 5806 KASA PROFİLİ (İÇ)
- 3 5717 CAM ÇITASI
- 4 KÖŞE ÇAVUŞU
- 5 5738 KÖŞE TAKOZU
- 6 4401 EPDM FİTİL (İÇ CAM)
- 7 4400 EPDM FİTİL (DIŞ CAM)
- 8 İÇ KAPLAMA

- 9 DIŞ KAPLAMA
- 10 SU YALITIM MEMBRANI
- 11 ÇELİK KÖRKASA

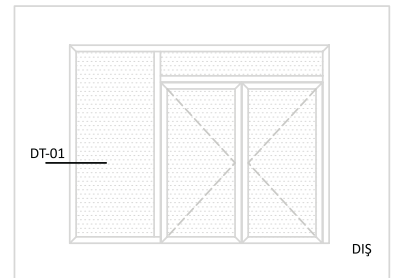

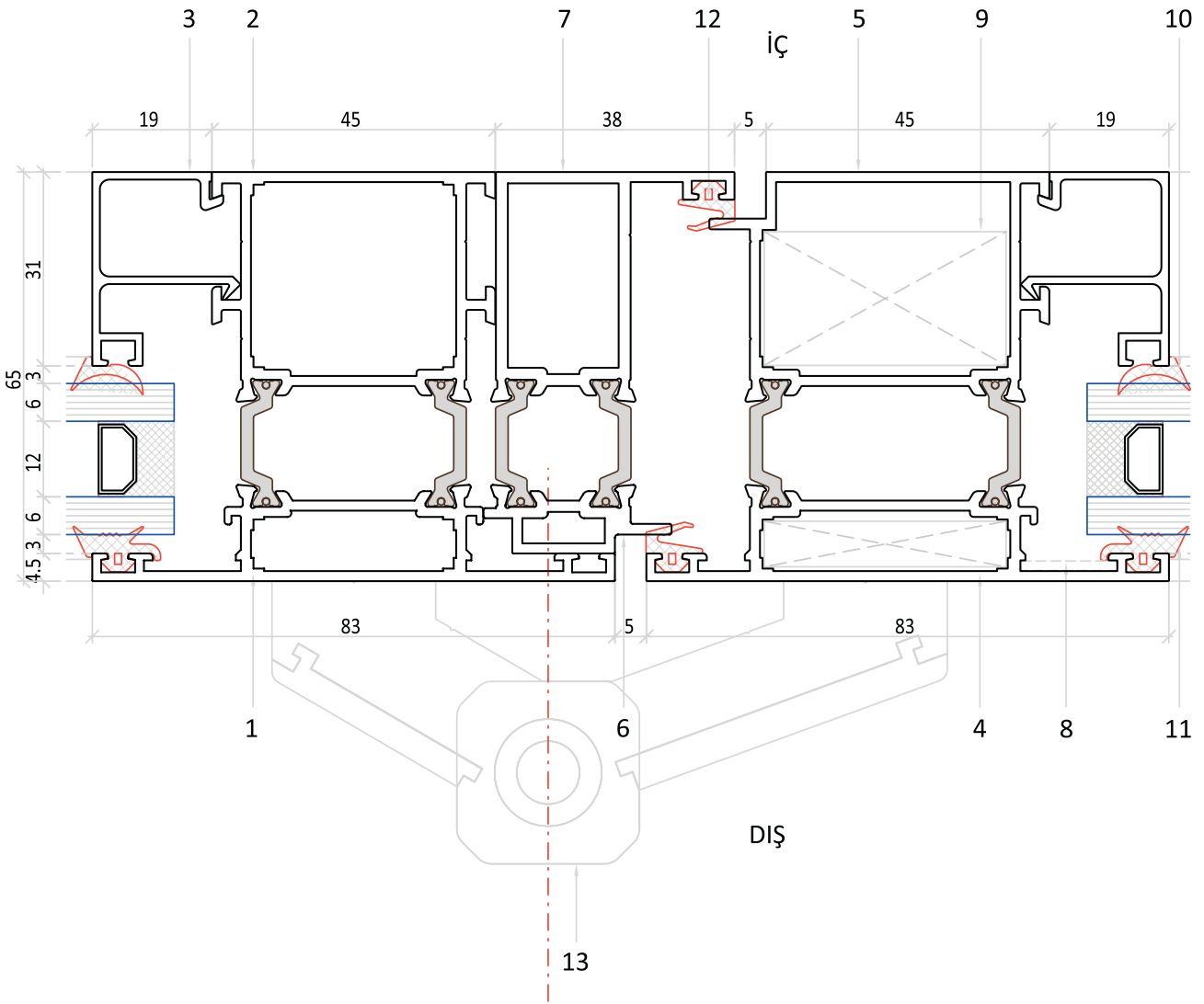

1 5807 ORTA KAYIT PROFİLİ (DIŞ)

2 5806 ORTA KAYIT PROFİLİ (İÇ)

3 5717 CAM ÇİTASI

4 5813 İÇE-DIŞA KANAT PROFİLİ (DIŞ)

5 5812 İÇE-DIŞA KANAT PROFİLİ (İÇ)

6 5729 DIŞA AÇILIM ADAPTÖRÜ (DIŞ)

7 5728 DIŞA AÇILIM ADAPTÖRÜ (İÇ)

8 KÖŞE ÇAVUŞU

9 5739 KÖŞE TAKOZU

10 4401 EPDM FİTİL (İÇ CAM)

11 4400 EPDM FİTİL (DIŞ CAM)

12 4403 EPDM FİTİL

13 MENTEŞE

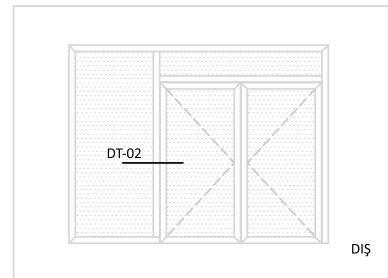

SBW 65 (1,6 mm) ADAPTÖRLÜ DIŞA AÇILIR SİSTEM / ÇİFT KANAT ORTA DETAYI

DT-03

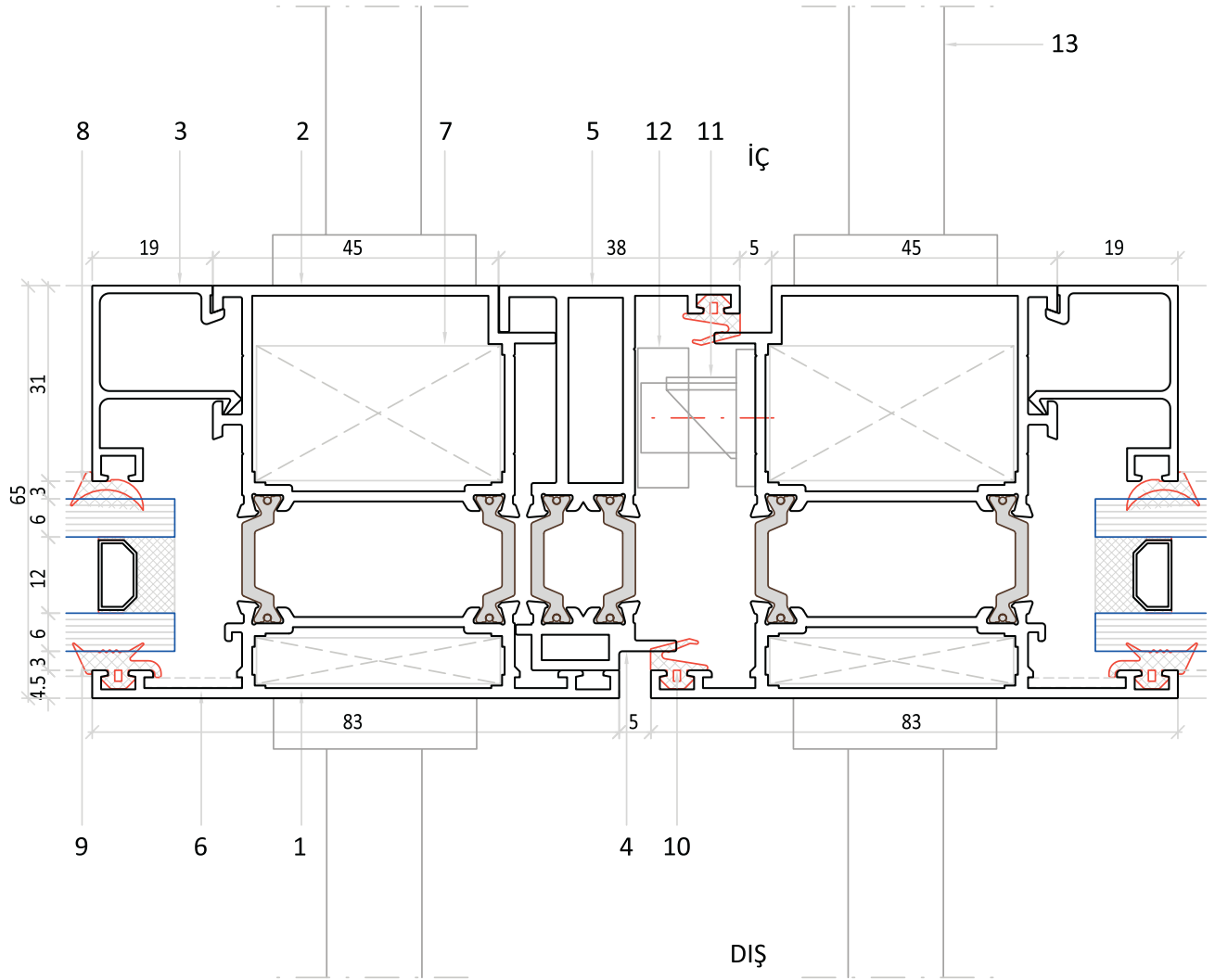

- 1 5813 İÇE-DIŞA KANAT PROFİLİ (DIŞ)
- 2 5812 İÇE-DIŞA KANAT PROFİLİ (İÇ)
- 3 5717 CAM ÇITASI
- 4 5731 DIŞA-ÇİFT KANAT ADAPTÖRÜ (DIŞ)
- 5 5730 DIŞA-ÇİFT KANAT ADAPTÖRÜ (İÇ)
- 6 KÖŞE ÇAVUŞU
- 7 5739 KÖŞE TAKOZU
- 8 4401 EPDM FİTİL (İÇ CAM)

- 9 4400 EPDM FİTİL (DIŞ CAM)
- 10 4403 EPDM FİTİL
- 11 KİLİT
- 12 KİLİT KARŞILIĞI
- 13 KOL

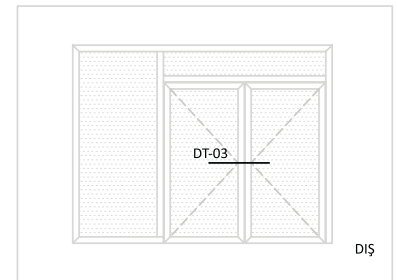

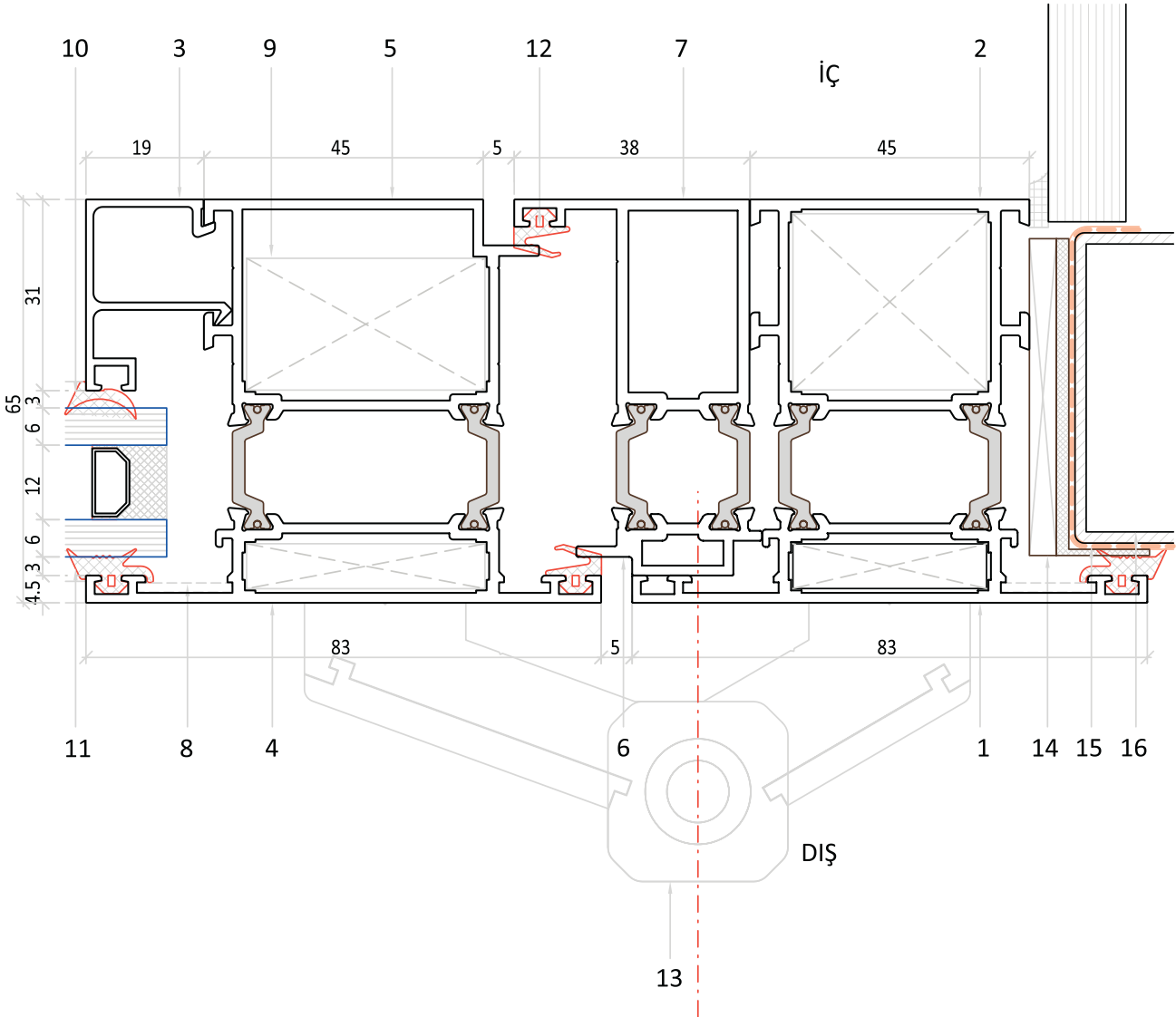

1 5807 KASA PROFİLİ (DIŞ)

2 5806 KASA PROFİLİ (İÇ)

3 5717 CAM ÇİTASI

4 5813 İÇE-DIŞA KANAT PROFİLİ (DIŞ)

5 5812 İÇE-DIŞA KANAT PROFİLİ (İÇ)

6 5729 DIŞA AÇILIM ADAPTÖRÜ (DIŞ)

7 5728 DIŞA AÇILIM ADAPTÖRÜ (İÇ)

8 KÖŞE ÇAVUŞU

9 5739 KÖŞE TAKOZU

10 4401 EPDM FİTİL (İÇ CAM)

11 4400 EPDM FİTİL (DIŞ CAM)

12 4403 EPDM FİTİL

13 MENTEŞE

14 PVC TAKOZ

15 SU YALITIM MEMBRANI

16 ÇELİK KÖRKASA

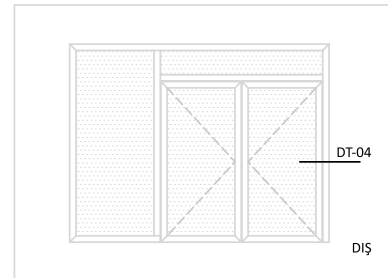

DT-05

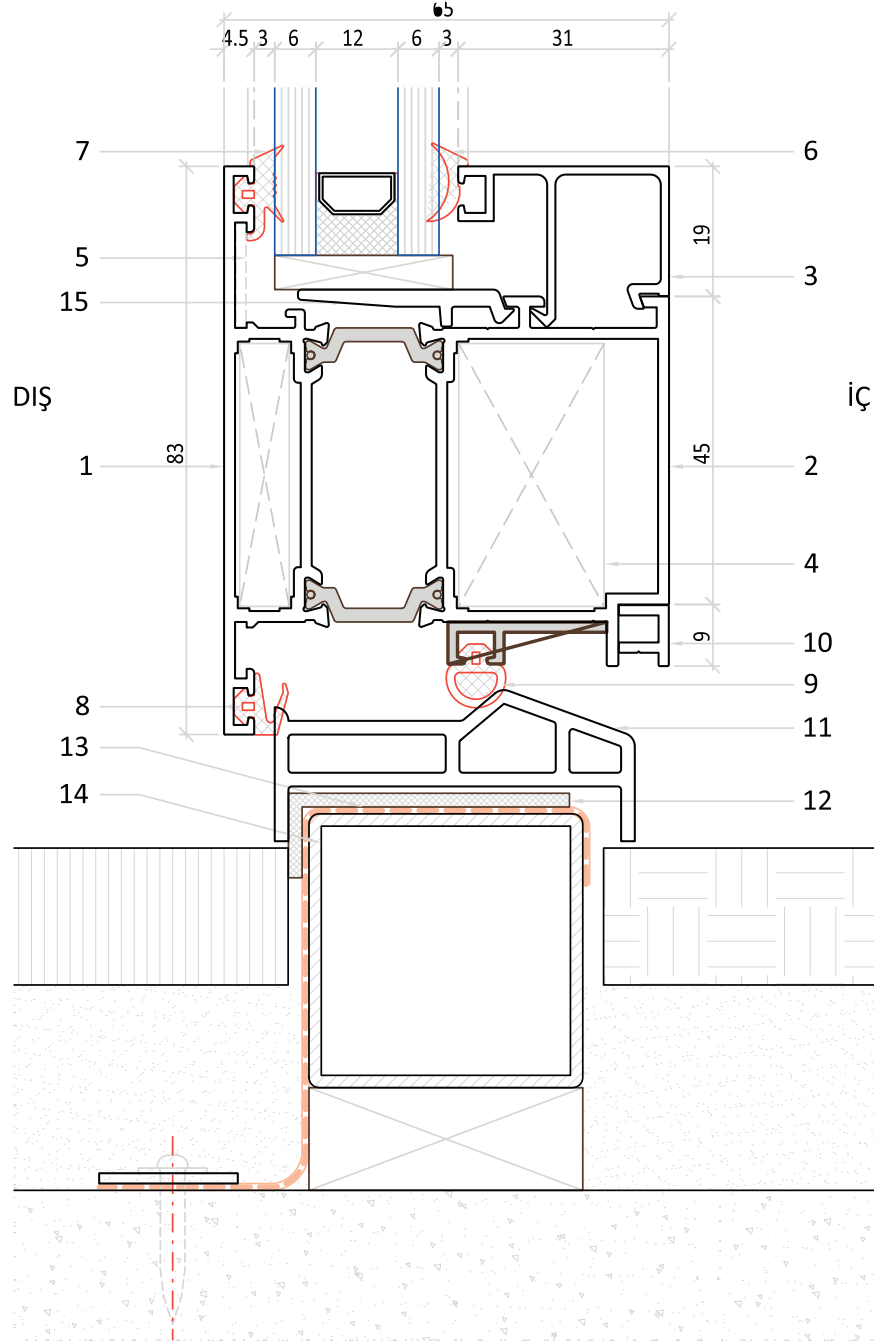

- 1 5813 İÇE-DIŞA KANAT PROFİLİ (DIŞ)
- 2 5812 İÇE-DIŞA KANAT PROFİLİ (İÇ)
- 3 5717 CAM ÇITASI
- 4 5739 KÖŞE TAKOZU
- 5 KÖŞE ÇAVUŞU
- 6 4401 EPDM FİTİL (İÇ CAM)
- 7 4400 EPDM FİTİL (DIŞ CAM)
- 8 4403 EPDM FİTİL

- 9 4404 EPDM EŞİK FİTİLİ
- 10 5735 EŞİK PROFİLİ
- 11 5734 EŞİK PROFİLİ
- 12 PVC TAKOZ
- 13 SU YALITIM MEMBRANI
- 14 ÇELİK KÖRKASA
- 15 5719 CAM TAKOZU

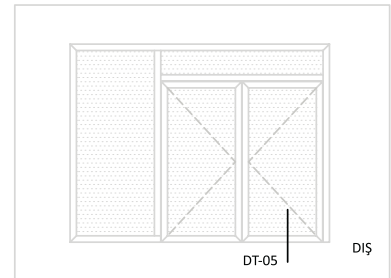

DT-06

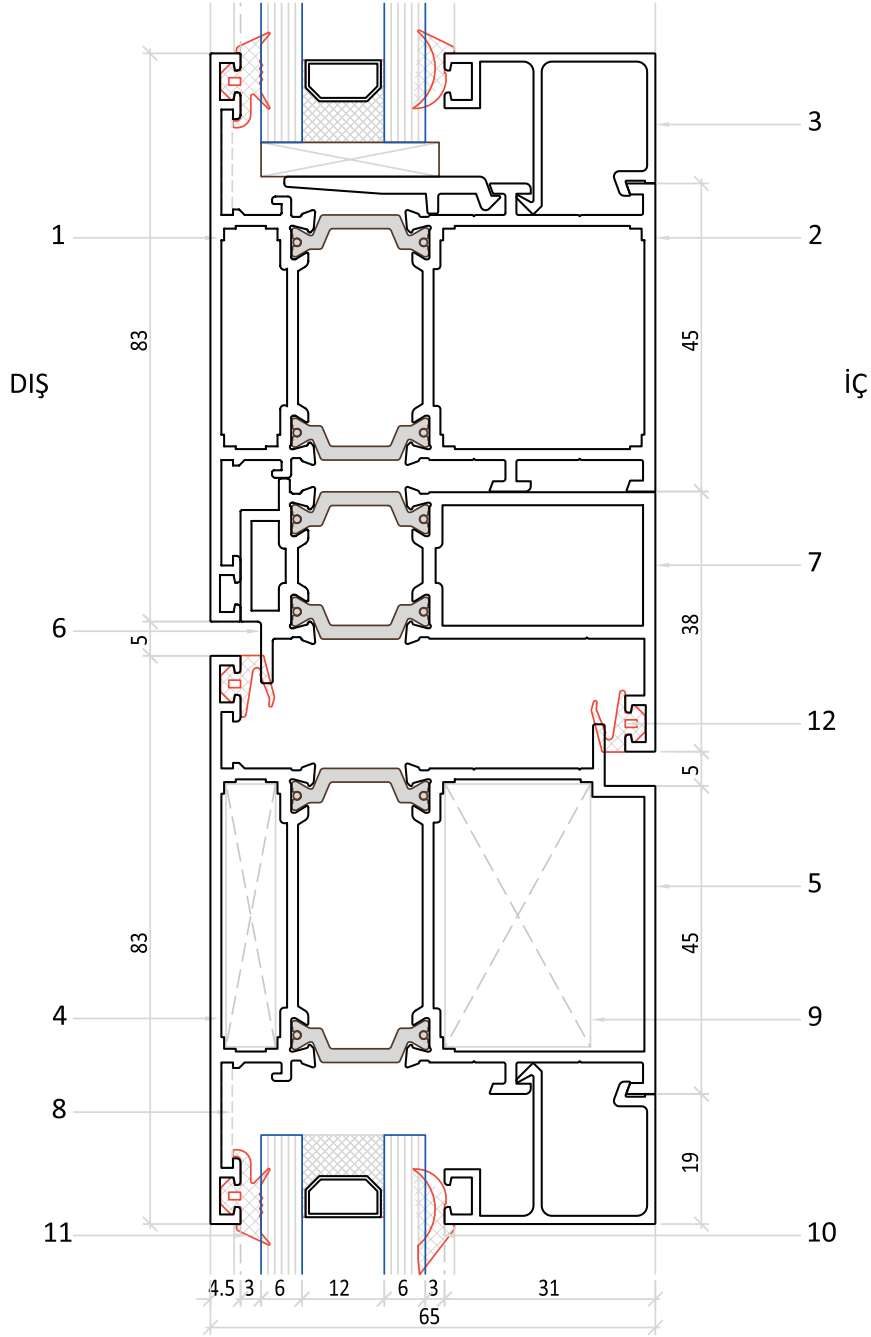

- 1 5807 ORTA KAYIT PROFİLİ (DIŞ)
- 2 5806 ORTA KAYIT PROFİLİ (İÇ)
- 3 5717 CAM ÇİTASI
- 4 5813 İÇE-DIŞA KANAT PROFİLİ (DIŞ)
- 5 5812 İÇE-DIŞA KANAT PROFİLİ (İÇ)
- 6 5729 DIŞA AÇILIM ADAPTÖRÜ (DIŞ)
- 7 5728 DIŞA AÇILIM ADAPTÖRÜ (İÇ)
- 8 KÖŞE ÇAVUŞU

- 9 5739 KÖŞE TAKOZU
- 10 4401 EPDM FİTİL (İÇ CAM)
- 11 4400 EPDM FİTİL (DIŞ CAM)
- 12 4403 EPDM FİTİL

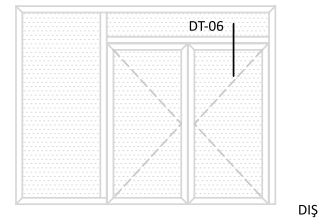



SBW 65 (1,6 mm) ADAPTÖRSÜZ DIŐA AÇILIR SİSTEM - ÇİFT KANAT DETAYI



**STARKBAU**  
ALÜMİNYUM PROFİL SİSTEMLERİ

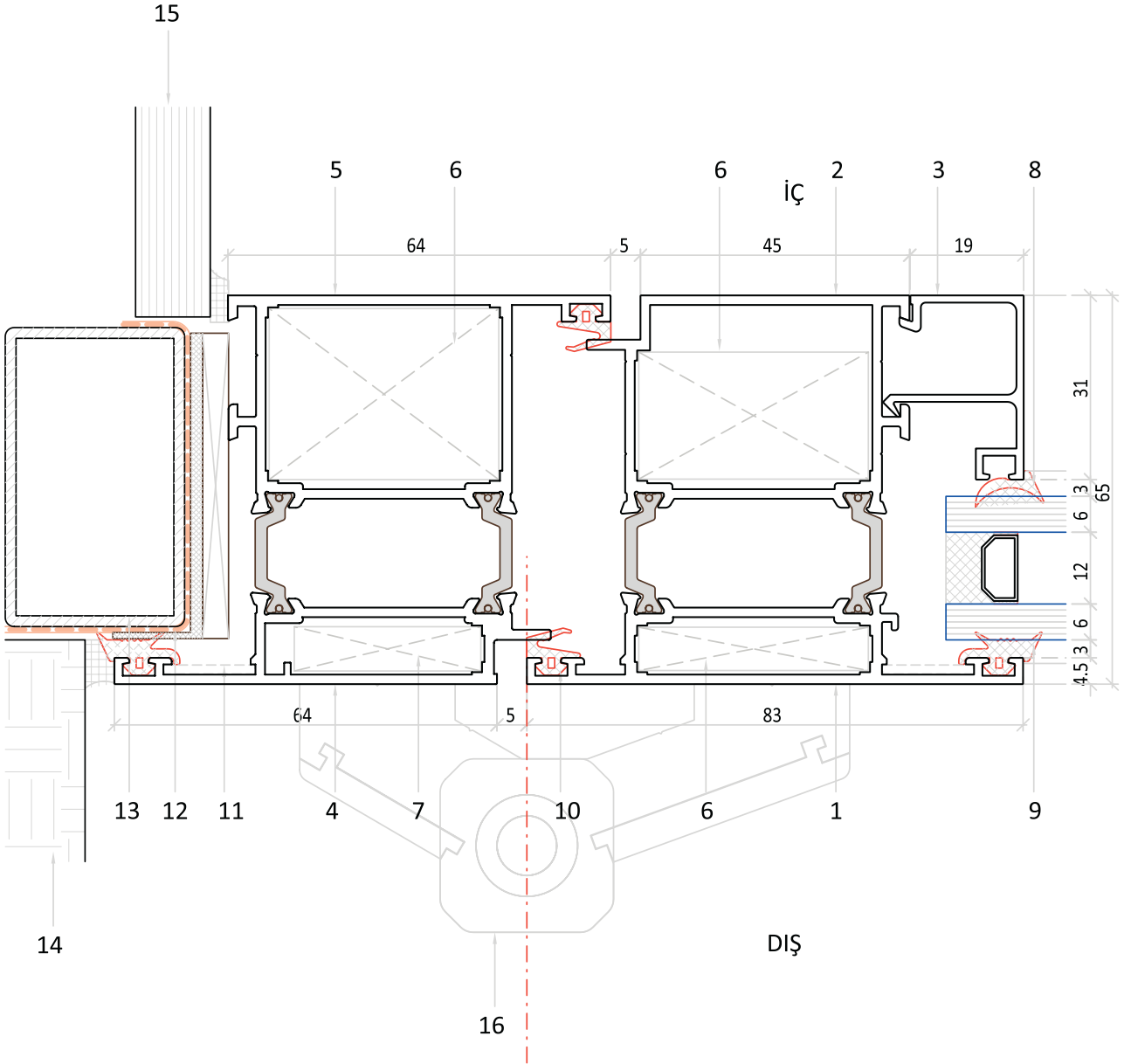

- |   |                                   |
|---|-----------------------------------|
| 1 | 5813 İÇE-DIŞA KANAT PROFİLİ (DIŞ) |
| 2 | 5812 İÇE-DIŞA KANAT PROFİLİ (İÇ)  |
| 3 | 5717 CAM ÇITASI                   |
| 4 | 5724 İÇE-DIŞA KANAT PROFİLİ (DIŞ) |
| 5 | 5723 İÇE-DIŞA KANAT PROFİLİ (İÇ)  |
| 6 | 5739 KÖŞE TAKOZU                  |
| 7 | 5738 KÖŞE TAKOZU                  |
| 8 | 4401 EPDM FİTİL (İÇ CAM)          |

- |    |                           |
|----|---------------------------|
| 9  | 4400 EPDM FİTİL (DIŞ CAM) |
| 10 | 4403 EPDM FİTİL           |
| 11 | KÖŞE ÇAVUŞU               |
| 12 | SU YALITIM MEMBRANI       |
| 13 | ÇELİK KÖRKASA             |
| 14 | DIŞ KAPLAMA               |
| 15 | İÇ KAPLAMA                |
| 16 | MENTEŞE                   |

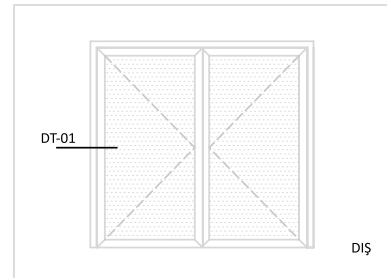

DT-02

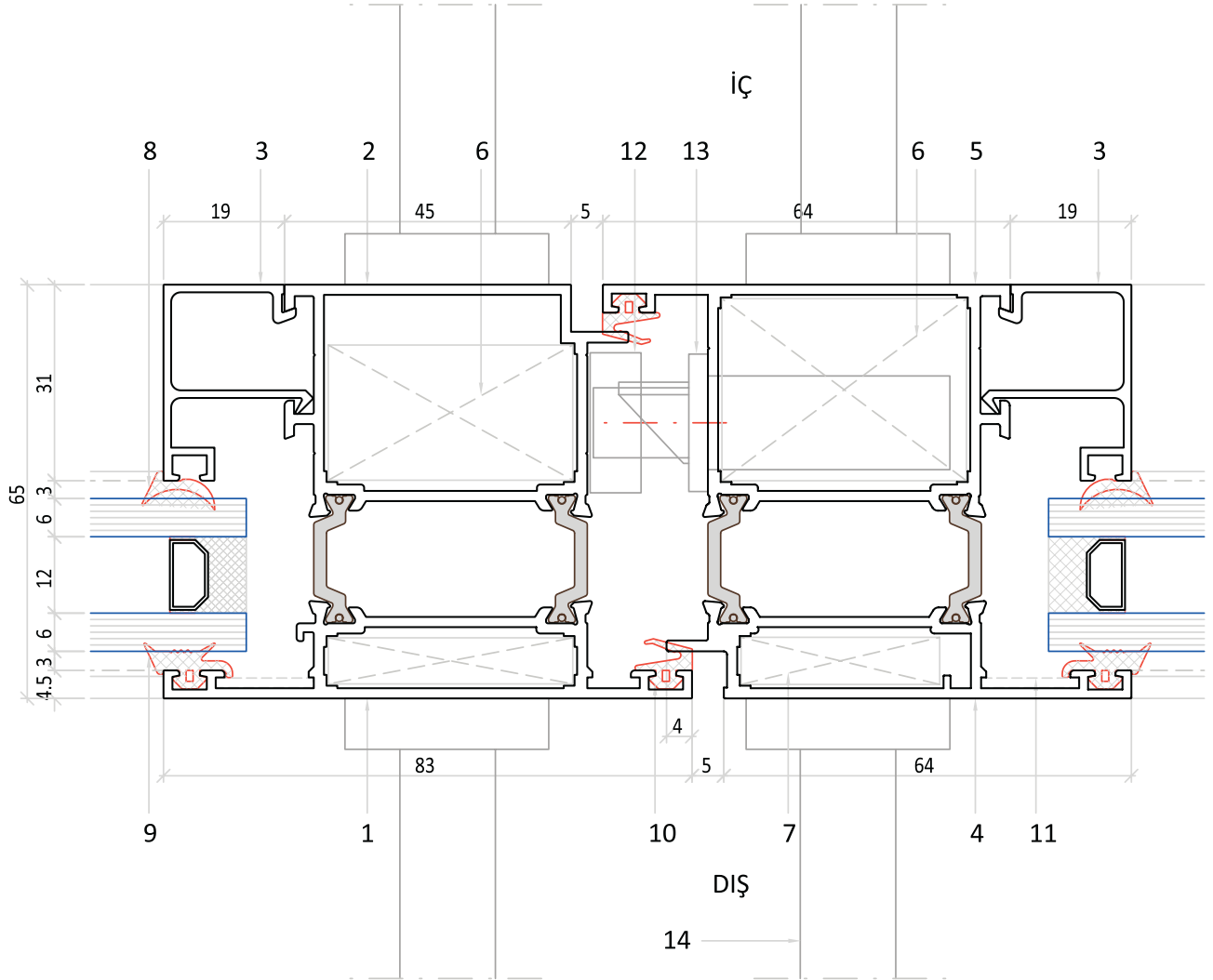

- 1 5813 İÇE-DIŞA KANAT PROFİLİ (DIŞ)
- 2 5812 İÇE-DIŞA KANAT PROFİLİ (İÇ)
- 3 5717 CAM ÇITASI
- 4 5815 İÇE-DIŞA KANAT PROFİLİ (DIŞ)
- 5 5814 İÇE-DIŞA KANAT PROFİLİ (İÇ)
- 6 5739 KÖŞE TAKOZU
- 7 5738 KÖŞE TAKOZU
- 8 4401 EPDM FİTİL (İÇ CAM)

- 9 4400 EPDM FİTİL (DIŞ CAM)
- 10 4403 EPDM FİTİL
- 11 KÖŞE ÇAVUŞU
- 12 KİLİT KARŞILIĞI
- 13 KİLİT
- 14 KOL

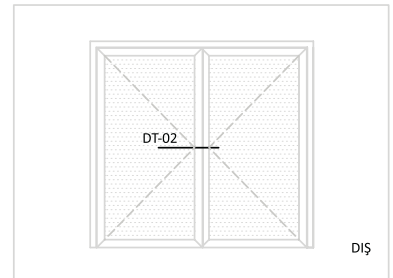

DT-03

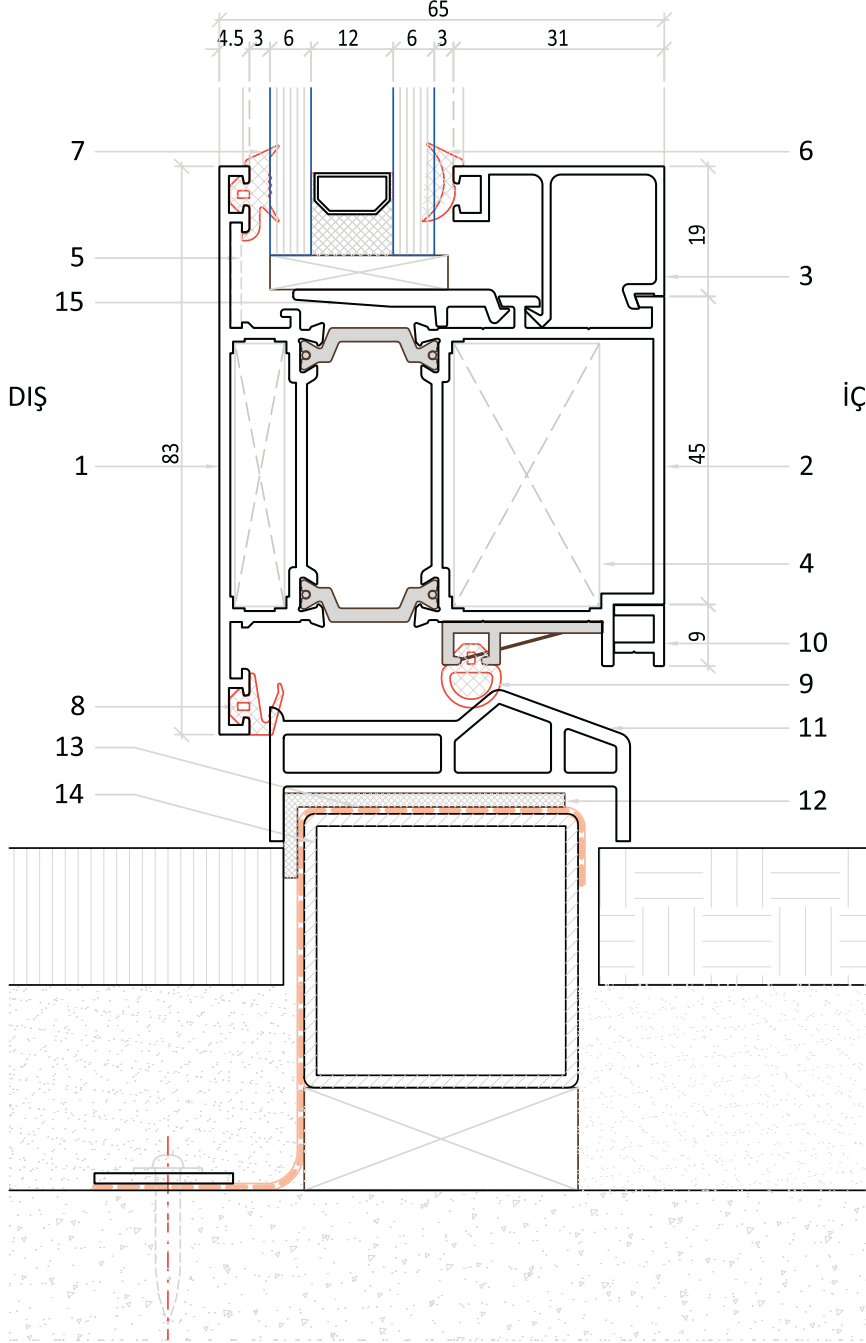

- 1 5813 İÇE-DIŞA KANAT PROFİLİ (DIŞ)
- 2 5812 İÇE-DIŞA KANAT PROFİLİ (İÇ)
- 3 5717 CAM ÇITASI
- 4 5739 KÖŞE TAKOZU
- 5 KÖŞE ÇAVUŞU
- 6 4401 EPDM FİTİL (İÇ CAM)
- 7 4400 EPDM FİTİL (DIŞ CAM)
- 8 4403 EPDM FİTİL

- 9 4404 EPDM EŞİK FİTİLİ
- 10 5735 EŞİK PROFİLİ
- 11 5734 EŞİK PROFİLİ
- 12 PVC TAKOZ
- 13 SU YALITIM MEMBRANI
- 14 ÇELİK KÖRKASA
- 15 5719 CAM TAKOZU

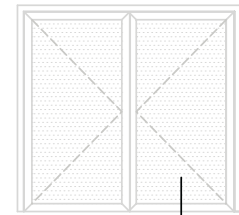

DT-03

DIŞ

SBW 65 (1,6 mm) ADAPTÖRSÜZ DIŐA AÇILIR SİSTEM - TEK KANAT DETAYI



**STARKBAU**  
ALÜMİNYUM PROFİL SİSTEMLERİ

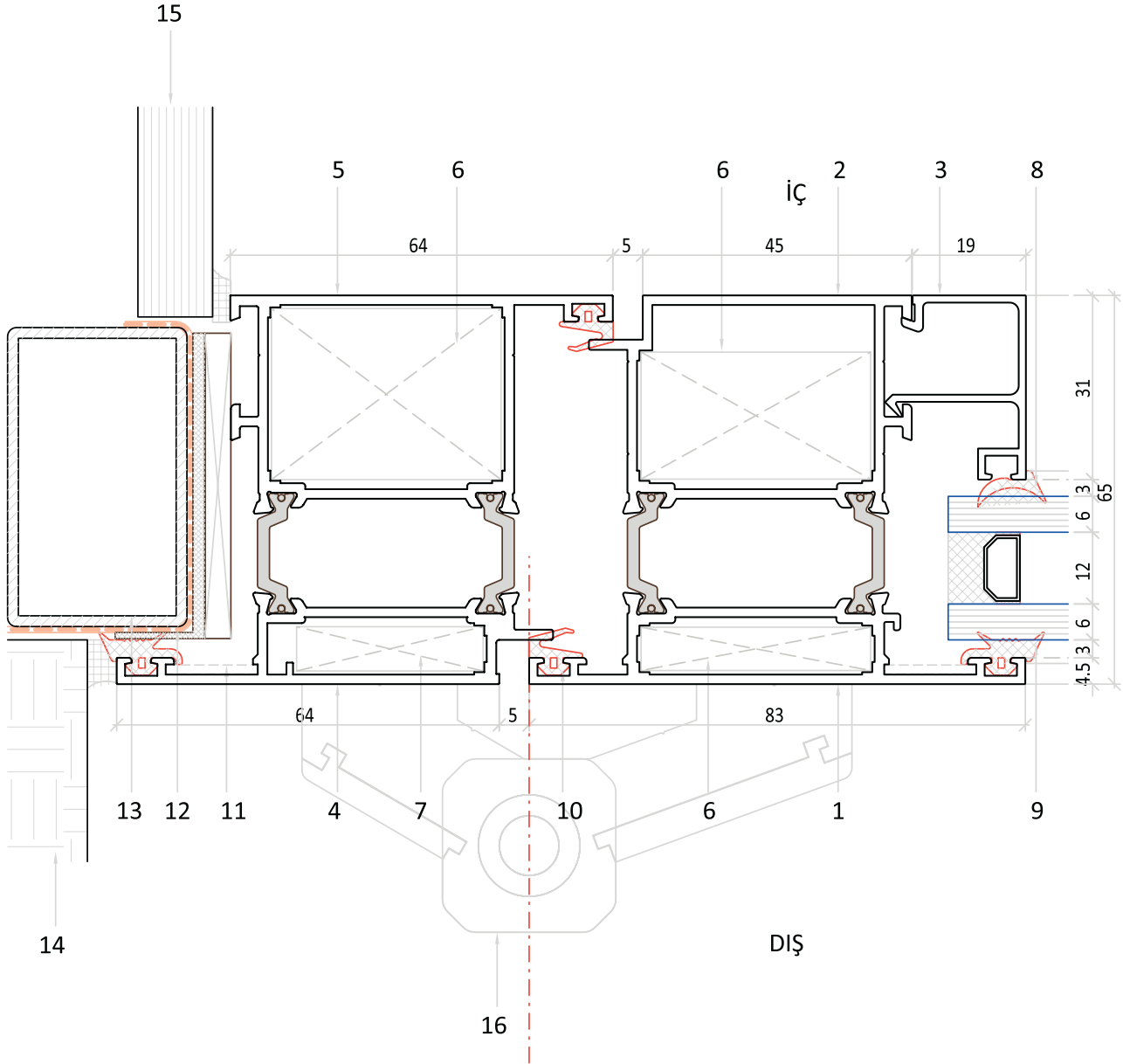

- 1 5813 İÇE-DIŞA KANAT PROFİLİ (DIŞ)
- 2 5812 İÇE-DIŞA KANAT PROFİLİ (İÇ)
- 3 5717 CAM ÇITASI
- 4 5815 İÇE-DIŞA KANAT PROFİLİ (DIŞ)
- 5 5814 İÇE-DIŞA KANAT PROFİLİ (İÇ)
- 6 5739 KÖŞE TAKOZU
- 7 5738 KÖŞE TAKOZU
- 8 4401 EPDM FİTİL (İÇ CAM)

- 9 4400 EPDM FİTİL (DIŞ CAM)
- 10 4403 EPDM FİTİL
- 11 KÖŞE ÇAVUŞU
- 12 SU YALITIM MEMBRANI
- 13 ÇELİK KÖRKASA
- 14 DIŞ KAPLAMA
- 15 İÇ KAPLAMA
- 16 MENTEŞE

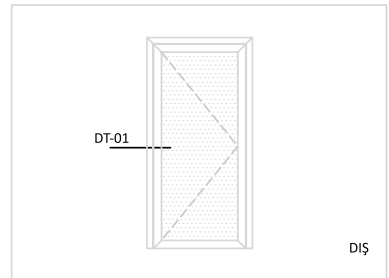

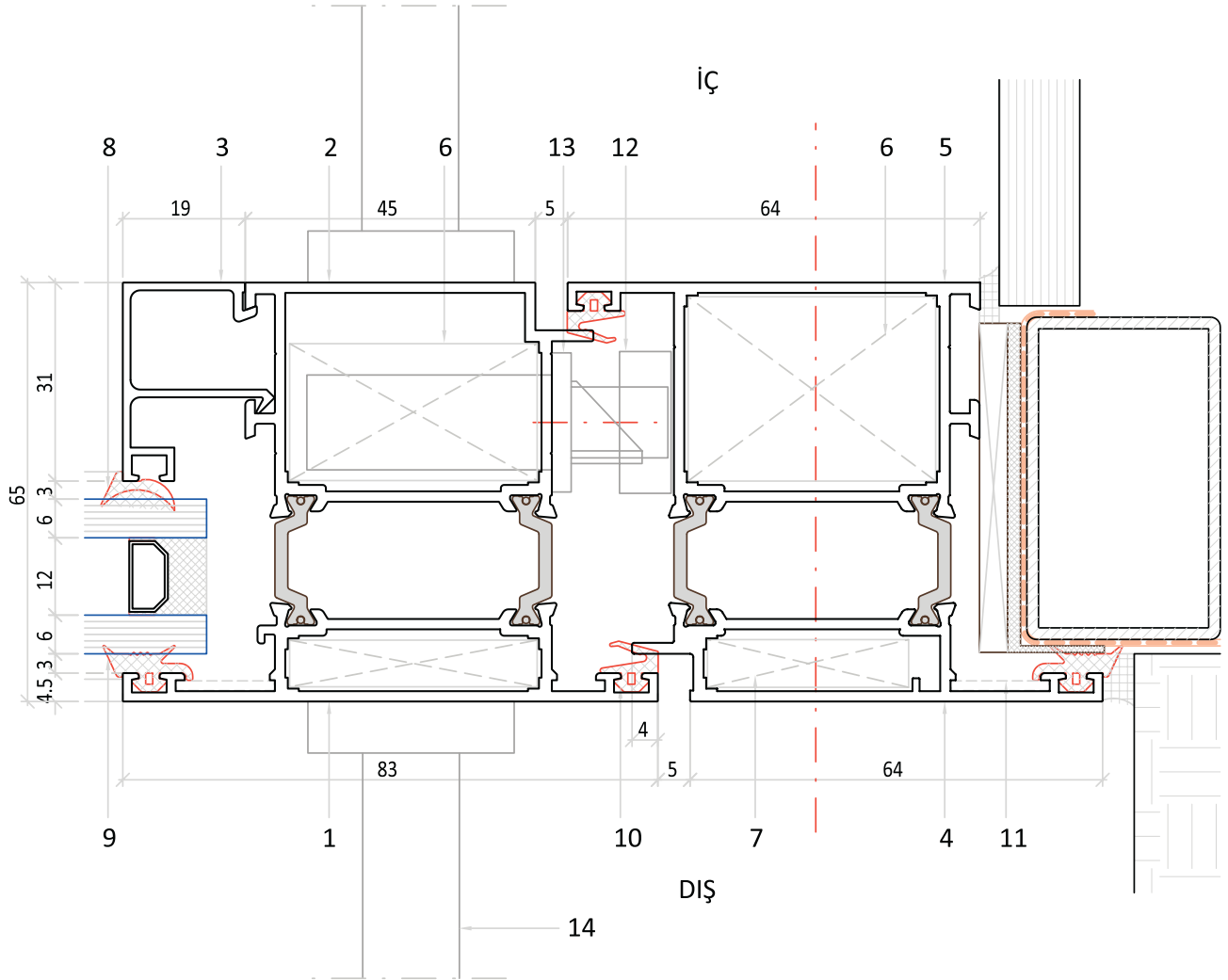

- 1 5813 İÇE-DIŞA KANAT PROFİLİ (DIŞ)
- 2 5812 İÇE-DIŞA KANAT PROFİLİ (İÇ)
- 3 5717 CAM ÇITASI
- 4 5815 İÇE-DIŞA KANAT PROFİLİ (DIŞ)
- 5 5814 İÇE-DIŞA KANAT PROFİLİ (İÇ)
- 6 5739 KÖŞE TAKOZU
- 7 5738 KÖŞE TAKOZU
- 8 4401 EPDM FİTİL (İÇ CAM)

- 9 4400 EPDM FİTİL (DIŞ CAM)
- 10 4403 EPDM FİTİL
- 11 KÖŞE ÇAVUŞU
- 12 KİLİT KARŞILIĞI
- 13 KİLİT
- 14 KOL

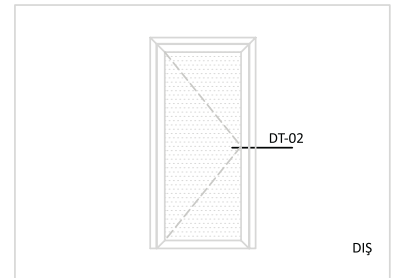

DT-03(1)

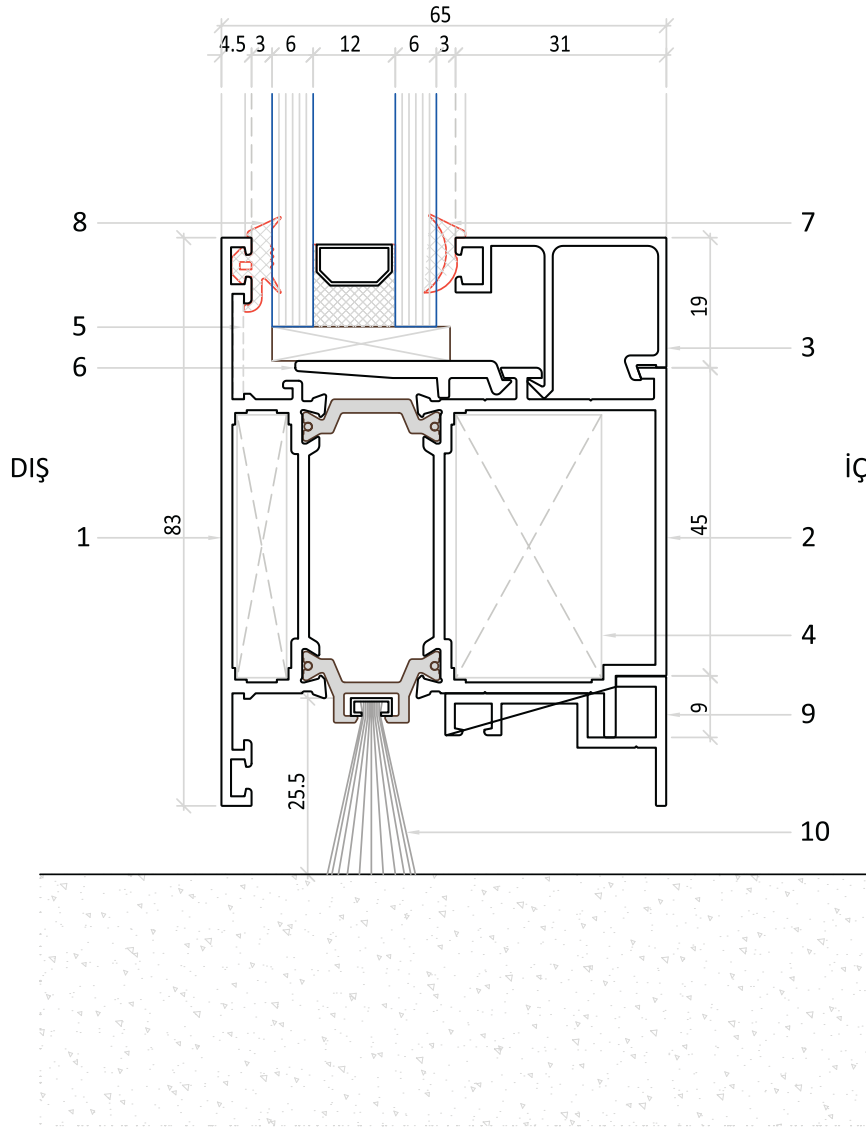

- 1 5813 İÇE-DIŞA KANAT PROFİLİ (DIŞ)
- 2 5812 İÇE-DIŞA KANAT PROFİLİ (İÇ)
- 3 5717 CAM ÇİTASI
- 4 5739 KÖŞE TAKOZU
- 5 KÖŞE ÇAVUŞU
- 6 5719 CAM TAKOZU
- 7 4401 EPDM FİTİL (İÇ CAM)
- 8 4400 EPDM FİTİL (DIŞ CAM)

- 9 5746 EŞİK PROFİLİ
- 10 FIRÇA

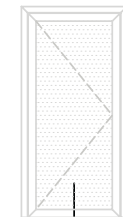

DT-03(1)

DIŞ



SBW 65 (1,6 mm) ADAPTÖRSÜZ DIŞA AÇILIR SİSTEM - TEK KANAT / KANAT ETEK PROFİLİ DETAYI

DT-03(2)

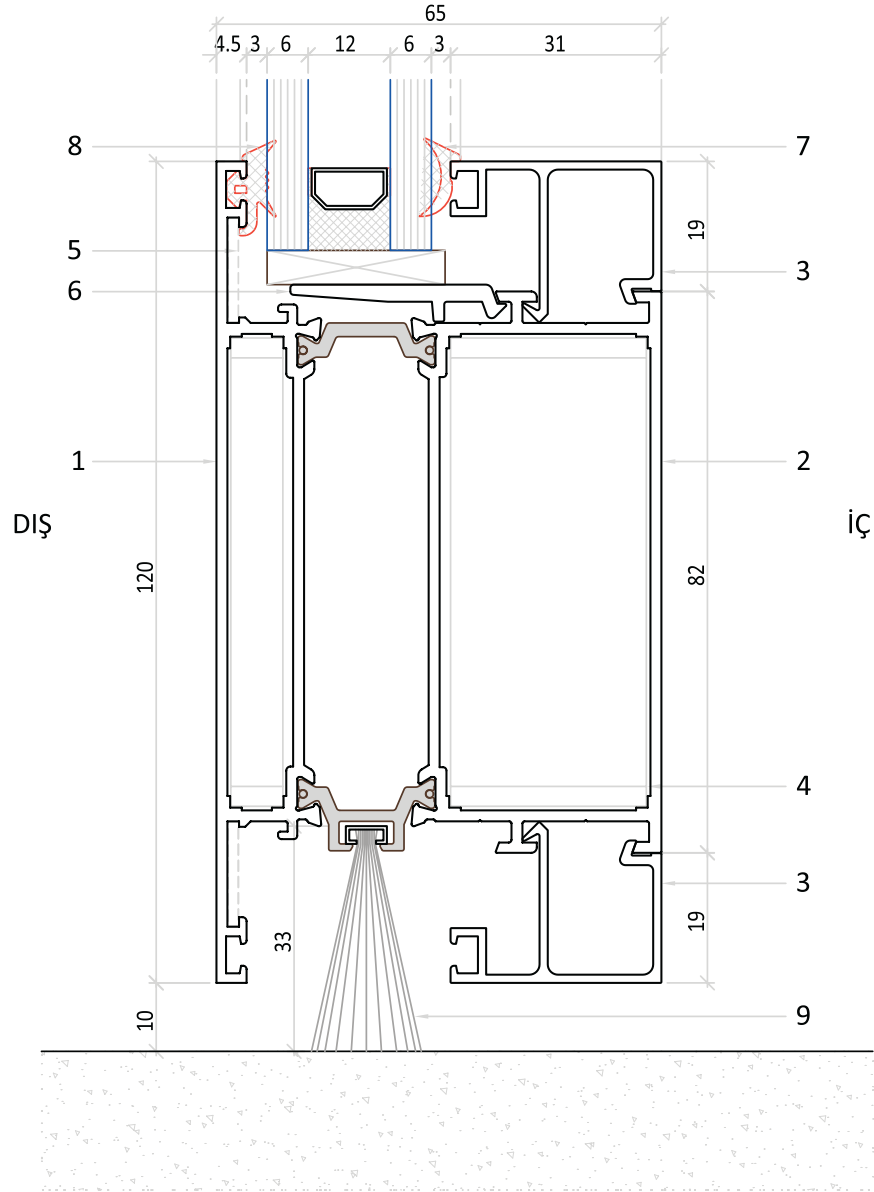

- 1 5816 ALT ETEK PROFİLİ (DIŞ)
- 2 5817 ALT ETEK PROFİLİ (İÇ)
- 3 5717 CAM ÇİTASI
- 4 U ÇEKTİRME PROFİLİ
- 5 KÖŞE ÇAVUŞU
- 6 5719 CAM TAKOZU
- 7 4401 EPDM FİTİL (İÇ CAM)
- 8 4400 EPDM FİTİL (DIŞ CAM)

9 FIRÇA

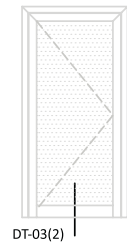

SBW 65 (1,6 mm) ADAPTÖRLÜ İÇE AÇILIR SİSTEM DETAYI



**STARKBAU**  
ALÜMİNYUM PROFİL SİSTEMLERİ

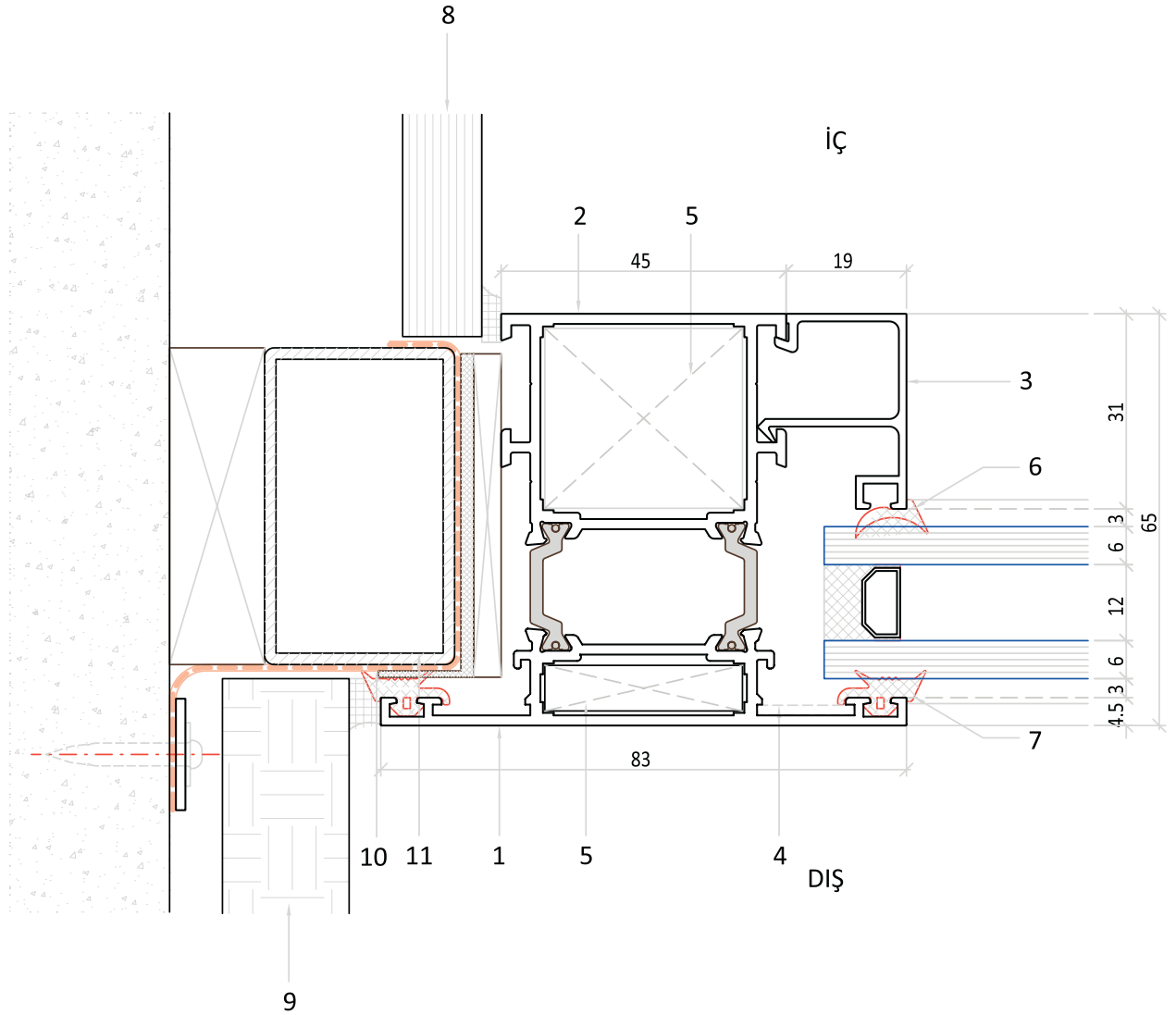

- 1 5807 KASA PROFİLİ (DIŞ)
- 2 5806 KASA PROFİLİ (İÇ)
- 3 5717 CAM ÇİTASI
- 4 KÖŞE ÇAVUŞU
- 5 5738 KÖŞE TAKOZU
- 6 4401 EPDM FİTİL (İÇ CAM)
- 7 4400 EPDM FİTİL (DIŞ CAM)
- 8 İÇ KAPLAMA

- 9 DIŞ KAPLAMA
- 10 SU YALITIM MEMBRANI
- 11 ÇELİK KÖRKASA

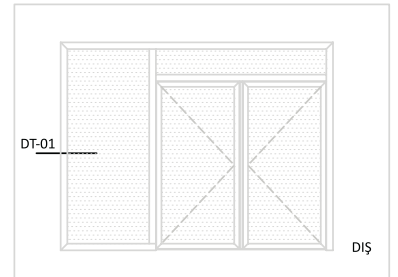

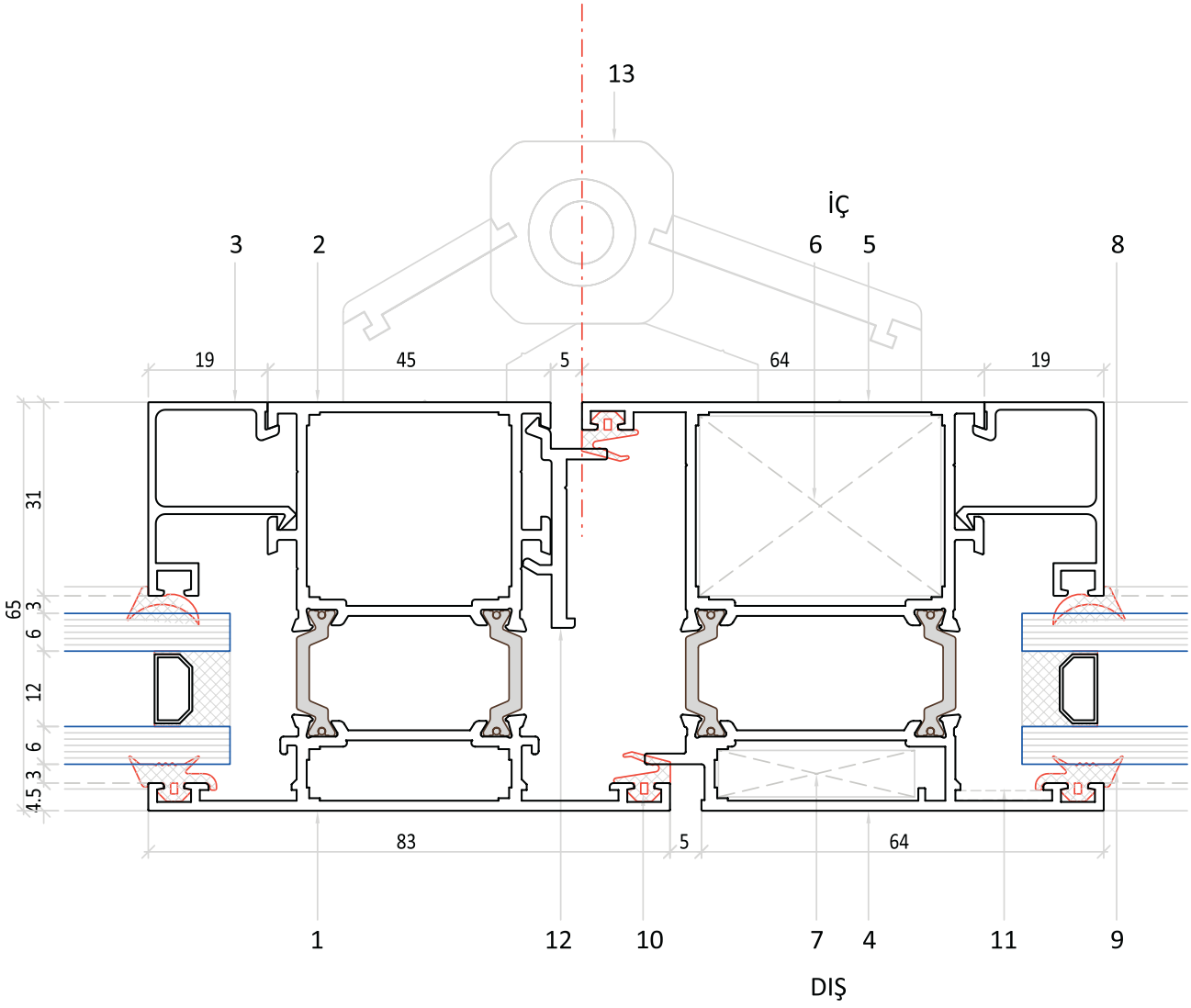

- 1 5807 ORTA KAYIT PROFİLİ (DIŞ)
- 2 5806 ORTA KAYIT PROFİLİ (İÇ)
- 3 5717 CAM ÇITASI
- 4 5815 İÇE-DIŞA KANAT PROFİLİ (DIŞ)
- 5 5814 İÇE-DIŞA KANAT PROFİLİ (İÇ)
- 6 5739 KÖŞE TAKOZU
- 7 5738 KÖŞE TAKOZU
- 8 4401 EPDM FİTİL (İÇ CAM)

- 9 4400 EPDM FİTİL (DIŞ CAM)
- 10 4403 EPDM FİTİL
- 11 KÖŞE ÇAVUŞU
- 12 5725 İÇE AÇILIM ADAPTÖRÜ
- 13 MENTEŞE

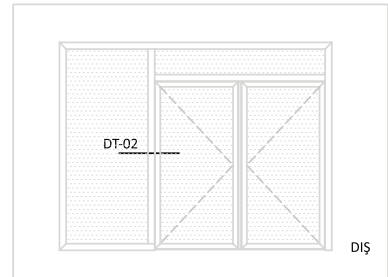

DT-03

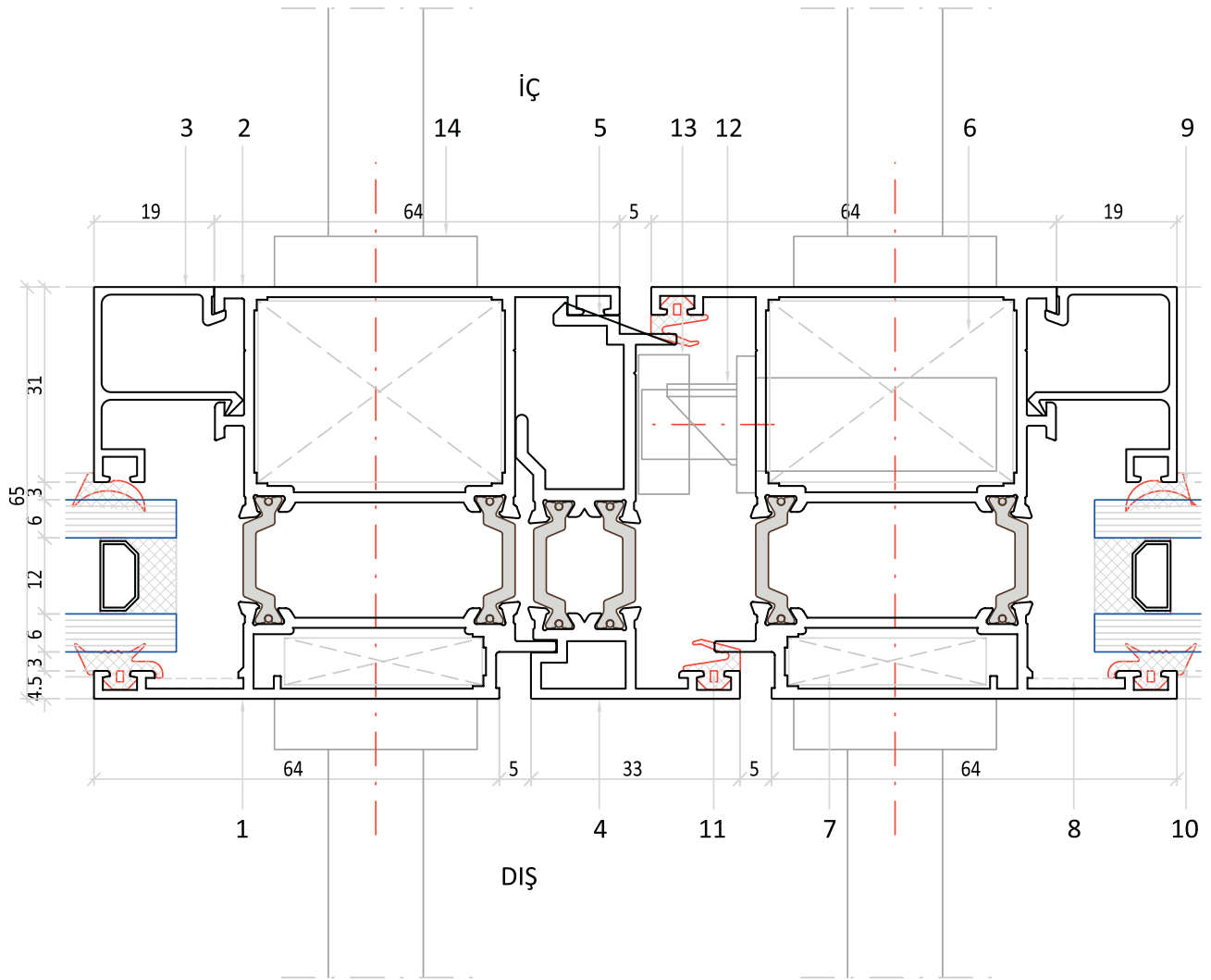

- |   |                                    |
|---|------------------------------------|
| 1 | 5815 İÇE-DIŞA KANAT PROFİLİ (DIŞ)  |
| 2 | 5814 İÇE-DIŞA KANAT PROFİLİ (İÇ)   |
| 3 | 5717 CAM ÇITASI                    |
| 4 | 5727 İÇE-ÇİFT KANAT ADAPTÖRÜ (DIŞ) |
| 5 | 5726 İÇE-ÇİFT KANAT ADAPTÖRÜ (İÇ)  |
| 6 | 5739 KÖŞE TAKOZU                   |
| 7 | 5738 KÖŞE TAKOZU                   |
| 8 | KÖŞE ÇAVUŞU                        |

- |    |                           |
|----|---------------------------|
| 9  | 4401 EPDM FİTİL (İÇ CAM)  |
| 10 | 4400 EPDM FİTİL (DIŞ CAM) |
| 11 | 4403 EPDM FİTİL           |
| 12 | KİLİT                     |
| 13 | KİLİT KARŞILIĞI           |
| 14 | KOL                       |

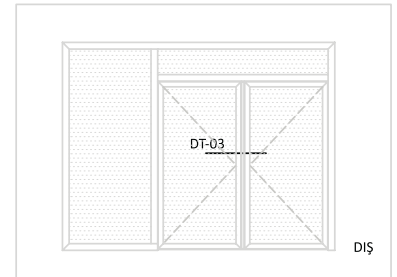

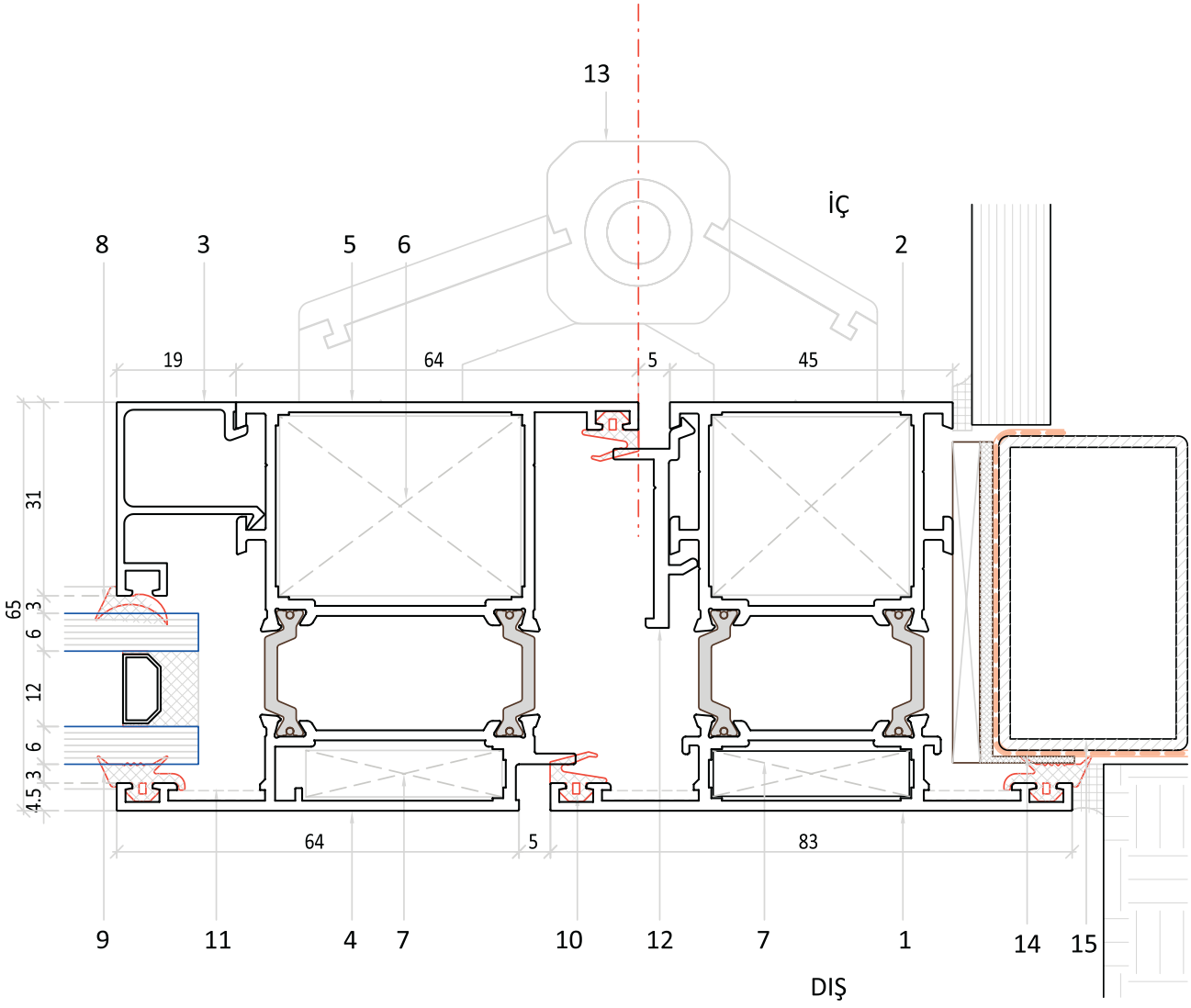

- 1 5807 KASA PROFİLİ (DIŞ)
- 2 5806 KASA PROFİLİ (İÇ)
- 3 5717 CAM ÇITASI
- 4 5815 İÇE-DIŞA KANAT PROFİLİ (DIŞ)
- 5 5814 İÇE-DIŞA KANAT PROFİLİ (İÇ)
- 6 5739 KÖŞE TAKOZU
- 7 5738 KÖŞE TAKOZU
- 8 4401 EPDM FİTİL (İÇ CAM)

- 9 4400 EPDM FİTİL (DIŞ CAM)
- 10 4403 EPDM FİTİL
- 11 KÖŞE ÇAVUŞU
- 12 5725 İÇE AÇILIM ADAPTÖRÜ
- 13 MENTEŞE
- 14 SU YALITIM MEMBRANI
- 15 ÇELİK KÖRKASA

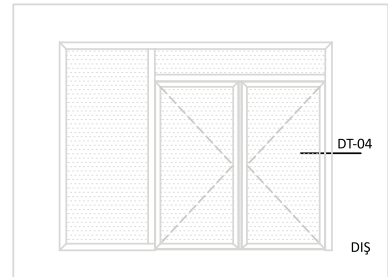

DT-05

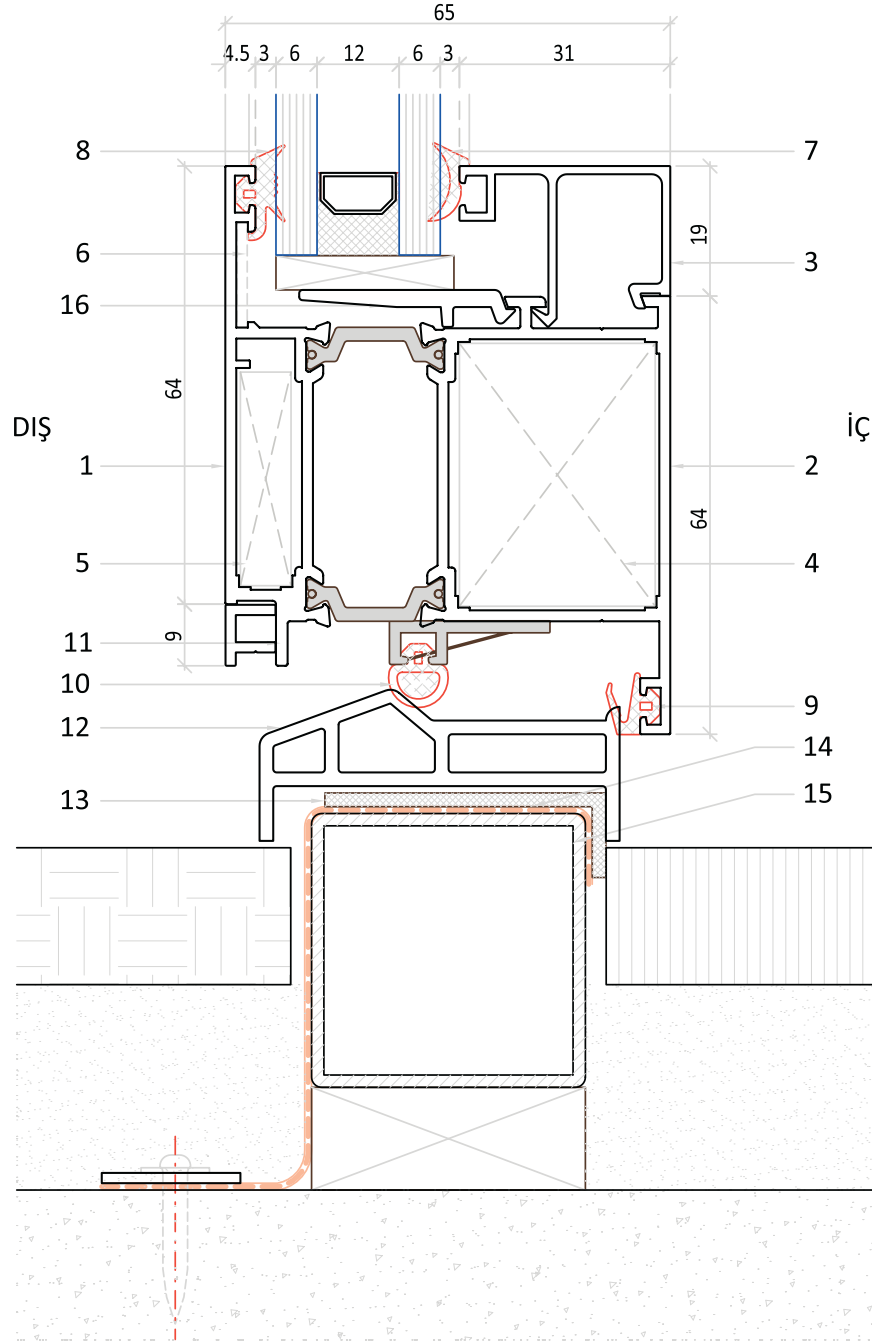

- 1 5815 İÇE-DIŞA KANAT PROFİLİ (DIŞ)
- 2 5814 İÇE-DIŞA KANAT PROFİLİ (İÇ)
- 3 5717 CAM ÇITASI
- 4 5739 KÖŞE TAKOZU
- 5 5738 KÖŞE TAKOZU
- 6 KÖŞE ÇAVUŞU
- 7 4401 EPDM FİTİL (İÇ CAM)
- 8 4400 EPDM FİTİL (DIŞ CAM)

- 9 4403 EPDM FİTİL
- 10 4404 EPDM EŞİK FİTİLİ
- 11 5735 EŞİK PROFİLİ
- 12 5734 EŞİK PROFİLİ
- 13 PVC BANT
- 14 SU YALITIM MEMBRANI
- 15 ÇELİK KÖRKASA
- 16 5719 CAM TAKOZU

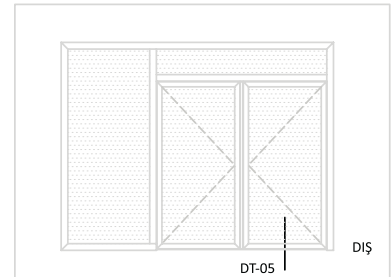

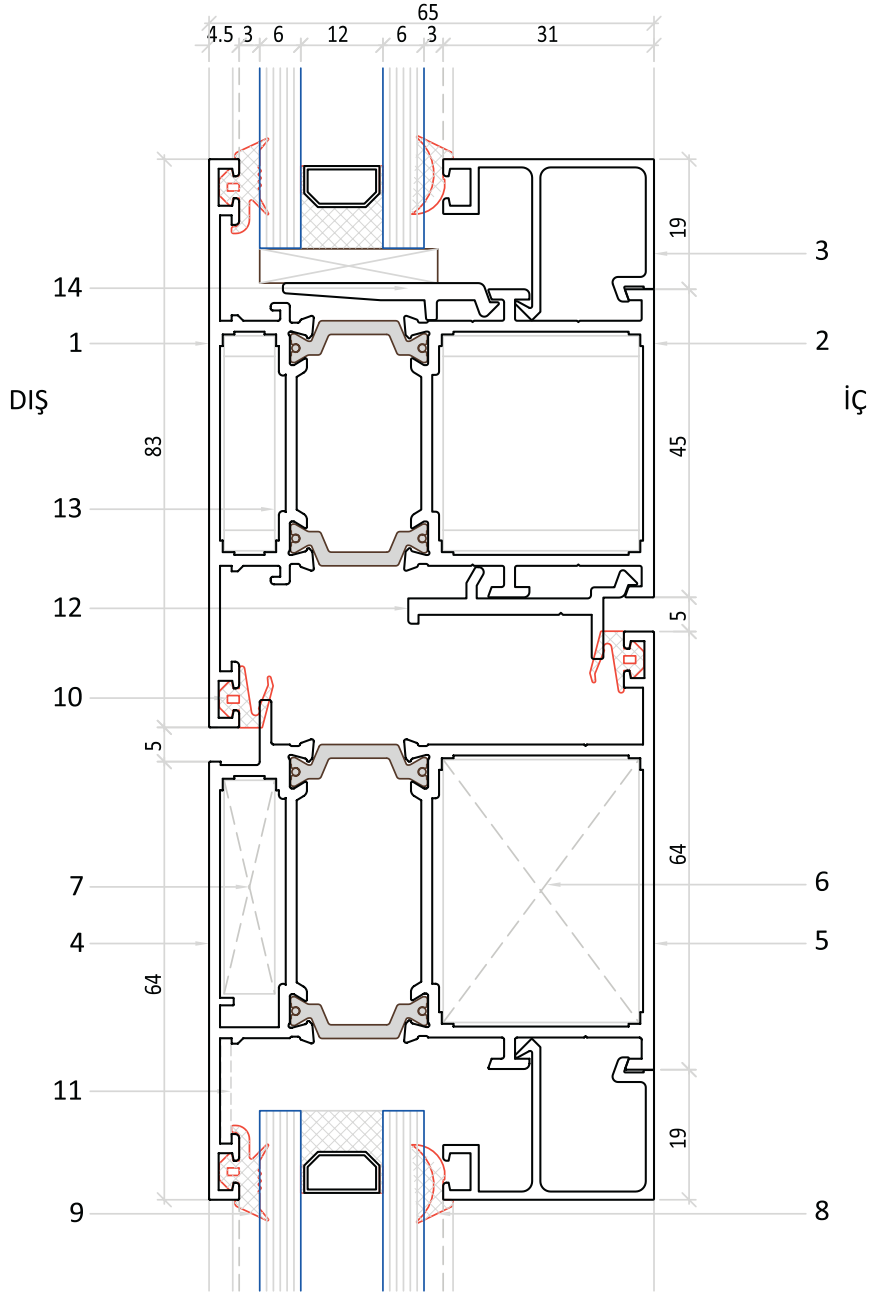

1 5807 ORTA KAYIT PROFİLİ (DIŞ)

2 5806 ORTA KAYIT PROFİLİ (İÇ)

3 5717 CAM ÇITASI

4 5815 İÇE-DIŞA KANAT PROFİLİ (DIŞ)

5 5814 İÇE-DIŞA KANAT PROFİLİ (İÇ)

6 5739 KÖŞE TAKOZU

7 5738 KÖŞE TAKOZU

8 4401 EPDM FİTİL (İÇ CAM)

9 4400 EPDM FİTİL (DIŞ CAM)

10 4403 EPDM FİTİL

11 KÖŞE ÇAVUŞU

12 5725 İÇE AÇILIM ADAPTÖRÜ

13 U ÇEKTİRME PROFİLİ

14 5719 CAM TAKOZU

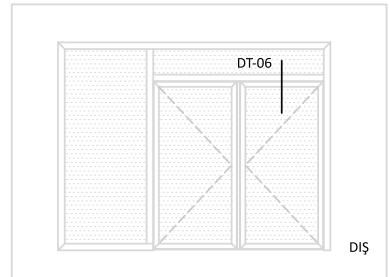



SBW 65 (1,6 mm) ADAPTÖRSÜZ İÇE AÇILIR SİSTEM DETAYI



STARKBAU  
ALÜMİNYUM PROFİL SİSTEMLERİ

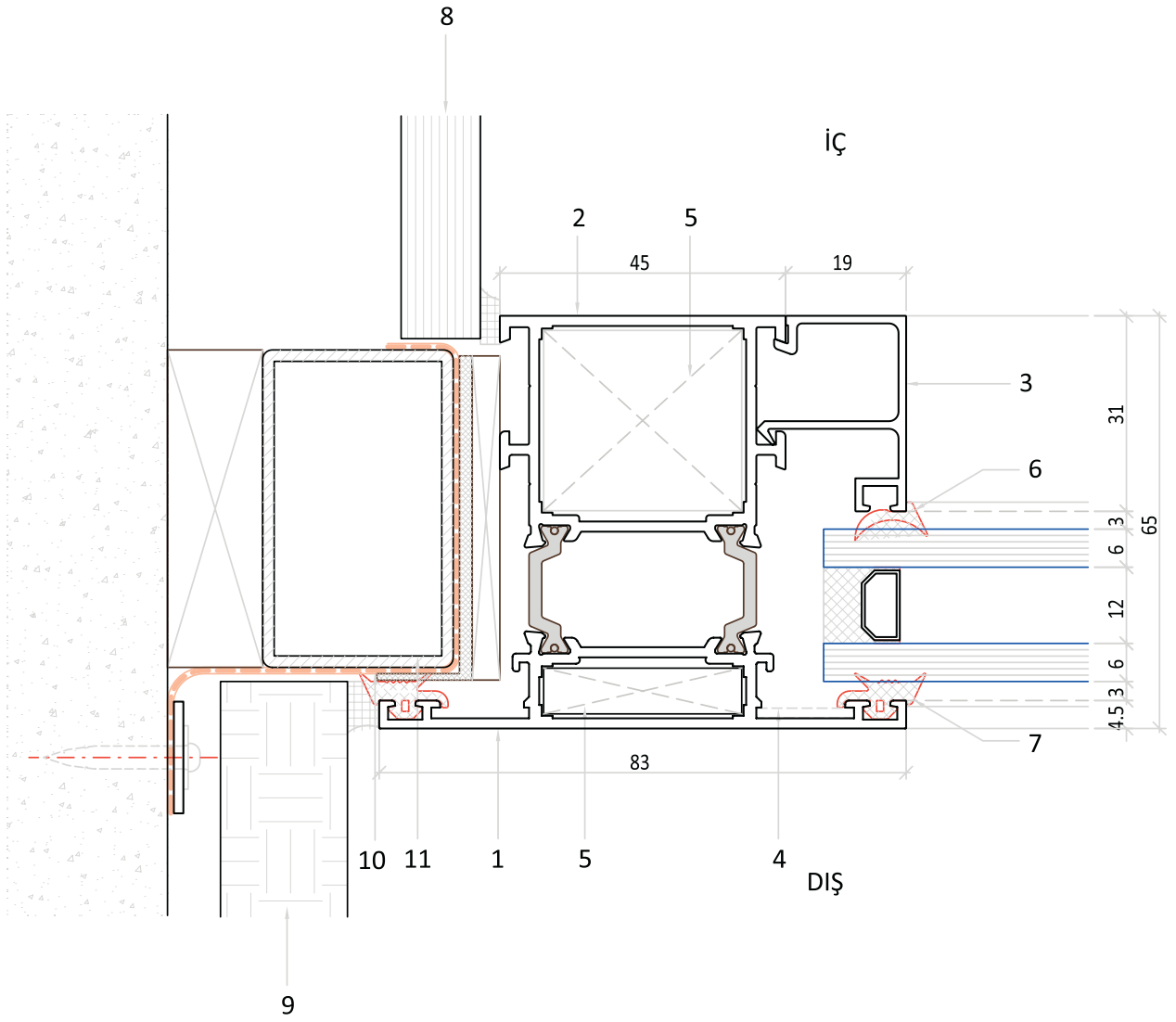

- 1 5807 KASA PROFİLİ (DIŞ)
- 2 5806 KASA PROFİLİ (İÇ)
- 3 5717 CAM ÇITASI
- 4 KÖŞE ÇAVUŞU
- 5 5738 KÖŞE TAKOZU
- 6 4401 EPDM FİTİL (İÇ CAM)
- 7 4400 EPDM FİTİL (DIŞ CAM)
- 8 İÇ KAPLAMA

- 9 DIŞ KAPLAMA
- 10 SU YALITIM MEMBRANI
- 11 ÇELİK KÖRKASA

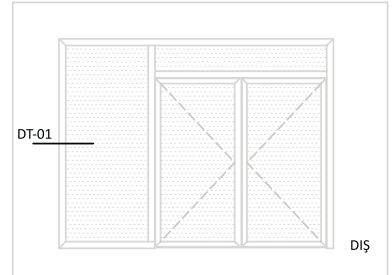

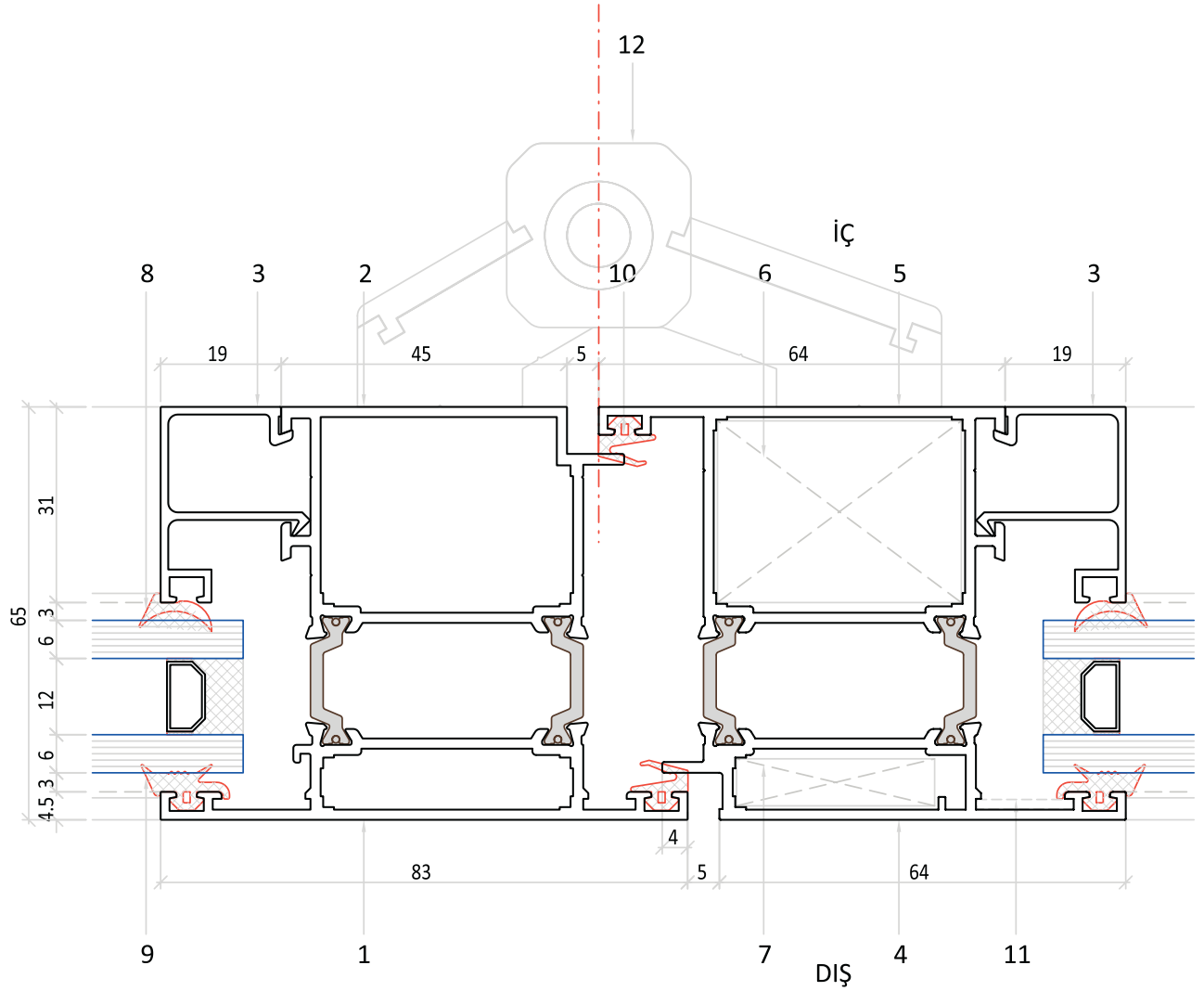

- 1 5813 İÇE-DIŞA KANAT PROFİLİ (DIŞ)
- 2 5812 İÇE-DIŞA KANAT PROFİLİ (İÇ)
- 3 5717 CAM ÇITASI
- 4 5815 İÇE-DIŞA KANAT PROFİLİ (DIŞ)
- 5 5814 İÇE-DIŞA KANAT PROFİLİ (İÇ)
- 6 5739 KÖŞE TAKOZU
- 7 5738 KÖŞE TAKOZU
- 8 4401 EPDM FİTİL (İÇ CAM)

- 9 4400 EPDM FİTİL (DIŞ CAM)
- 10 4403 EPDM FİTİL
- 11 KÖŞE ÇAVUŞU
- 12 MENTEŞE

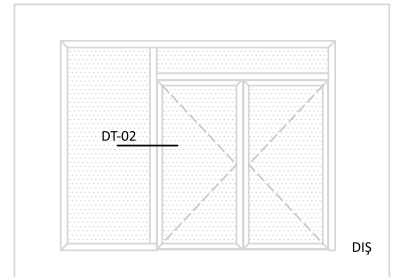

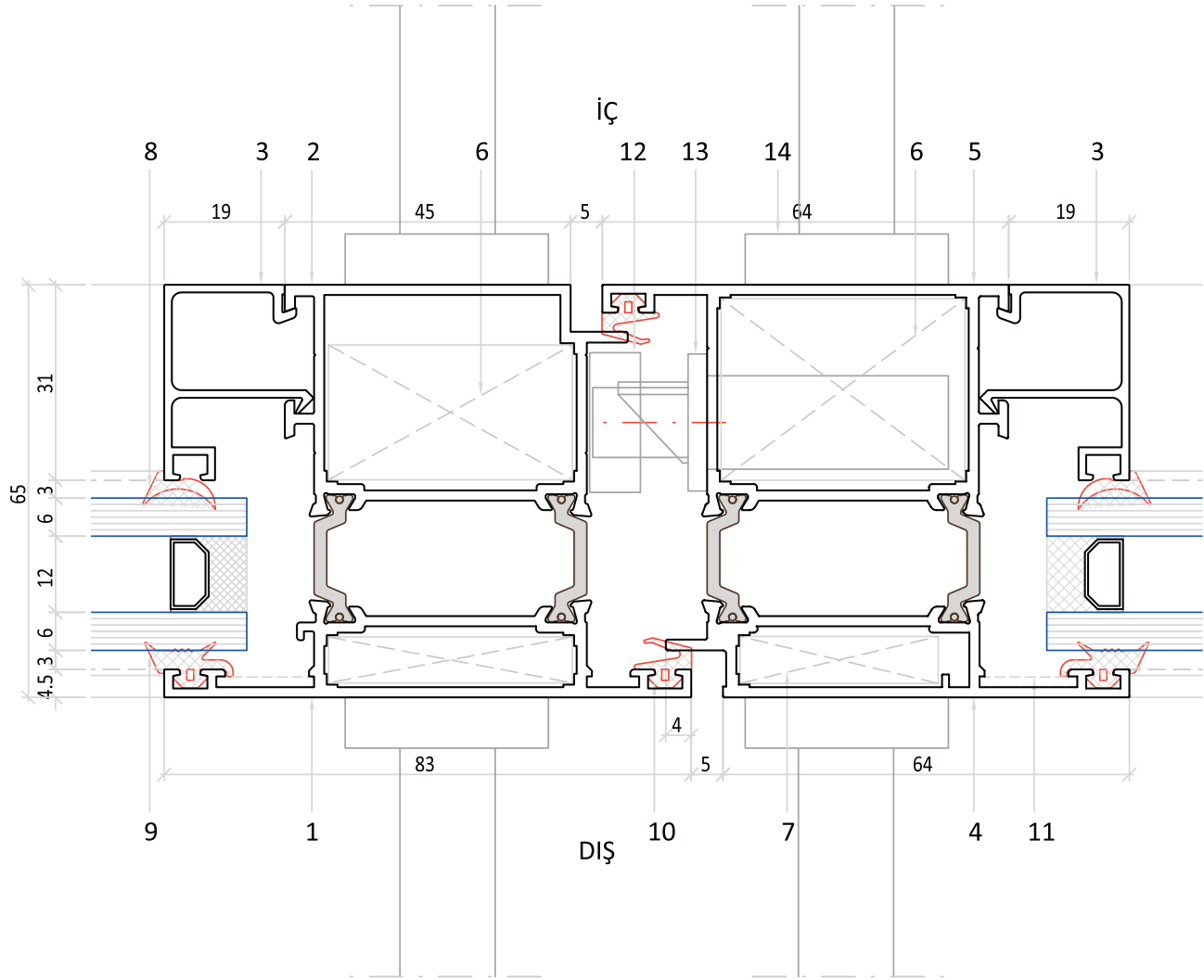

- 1 5813 İÇE-DIŞA KANAT PROFİLİ (DIŞ)
- 2 5812 İÇE-DIŞA KANAT PROFİLİ (İÇ)
- 3 5717 CAM ÇITASI
- 4 5815 İÇE-DIŞA KANAT PROFİLİ (DIŞ)
- 5 5814 İÇE-DIŞA KANAT PROFİLİ (İÇ)
- 6 5739 KÖŞE TAKOZU
- 7 5738 KÖŞE TAKOZU
- 8 4401 EPDM FİTİL (İÇ CAM)

- 9 4400 EPDM FİTİL (DIŞ CAM)
- 10 4403 EPDM FİTİL
- 11 KÖŞE ÇAVUŞU
- 12 KİLİT KARŞILIĞI
- 13 KİLİT
- 14 KOL

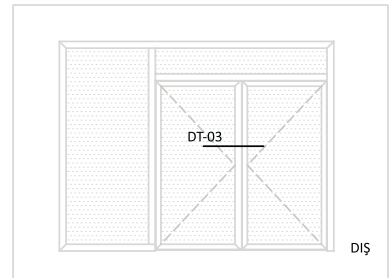

SBW 65 (1,6 mm) ADAPTÖRSÜZ İÇE AÇILIR SİSTEM / KANAT - KÖRKASA BİTİŞ DETAYI

DT-04

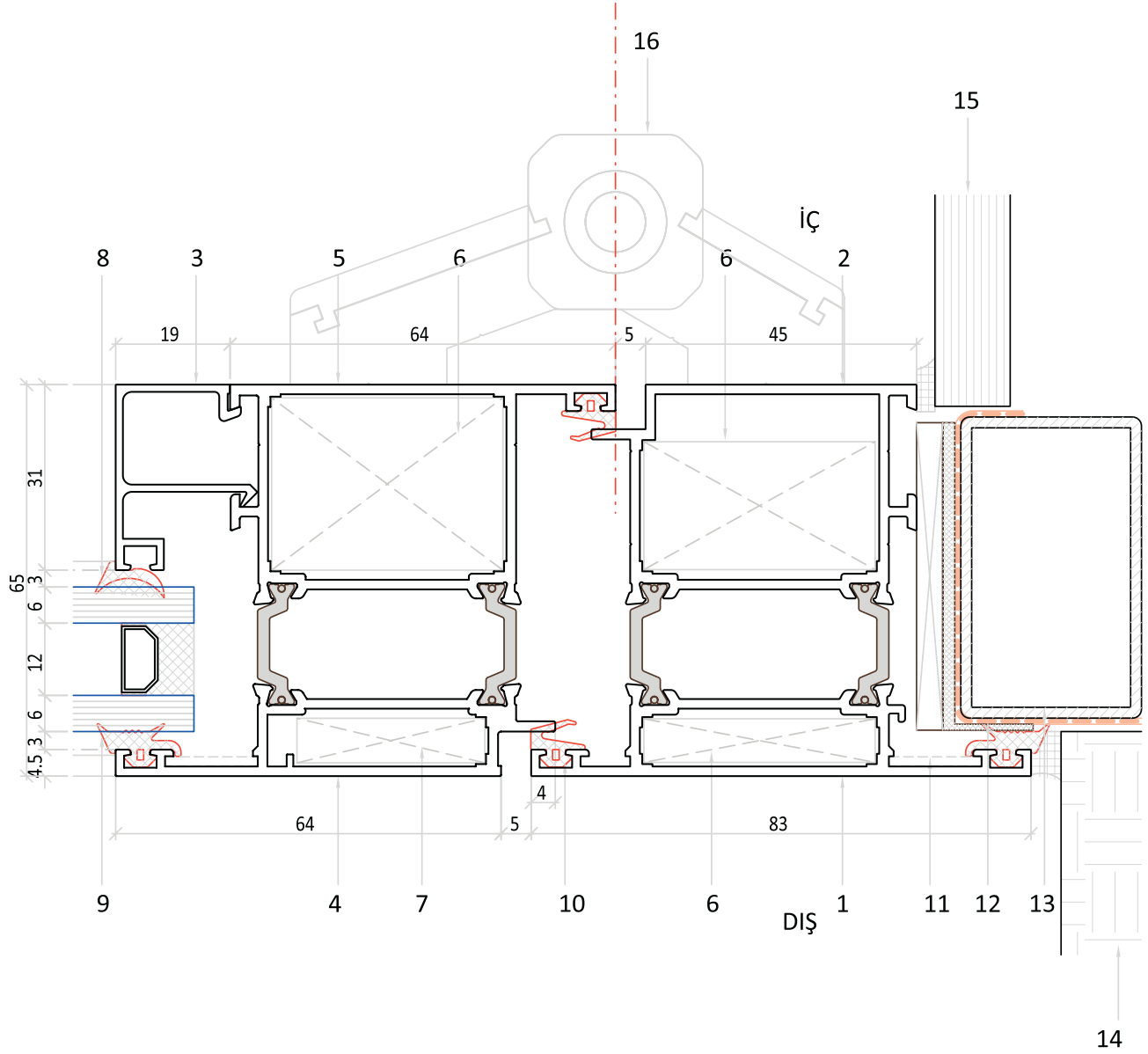

- 1 5813 İÇE-DIŞA KANAT PROFİLİ (DIŞ)
- 2 5812 İÇE-DIŞA KANAT PROFİLİ (İÇ)
- 3 5717 CAM ÇITASI
- 4 5815 İÇE-DIŞA KANAT PROFİLİ (DIŞ)
- 5 5814 İÇE-DIŞA KANAT PROFİLİ (İÇ)
- 6 5739 KÖŞE TAKOZU
- 7 5738 KÖŞE TAKOZU
- 8 4401 EPDM FİTİL (İÇ CAM)

- 9 4400 EPDM FİTİL (DIŞ CAM)
- 10 4403 EPDM FİTİL
- 11 KÖŞE ÇAVUŞU
- 12 SU YALITIM MEMBRANI
- 13 ÇELİK KÖRKASA
- 14 DIŞ KAPLAMA
- 15 İÇ KAPLAMA
- 16 MENTEŞE

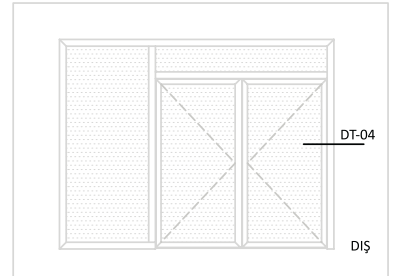

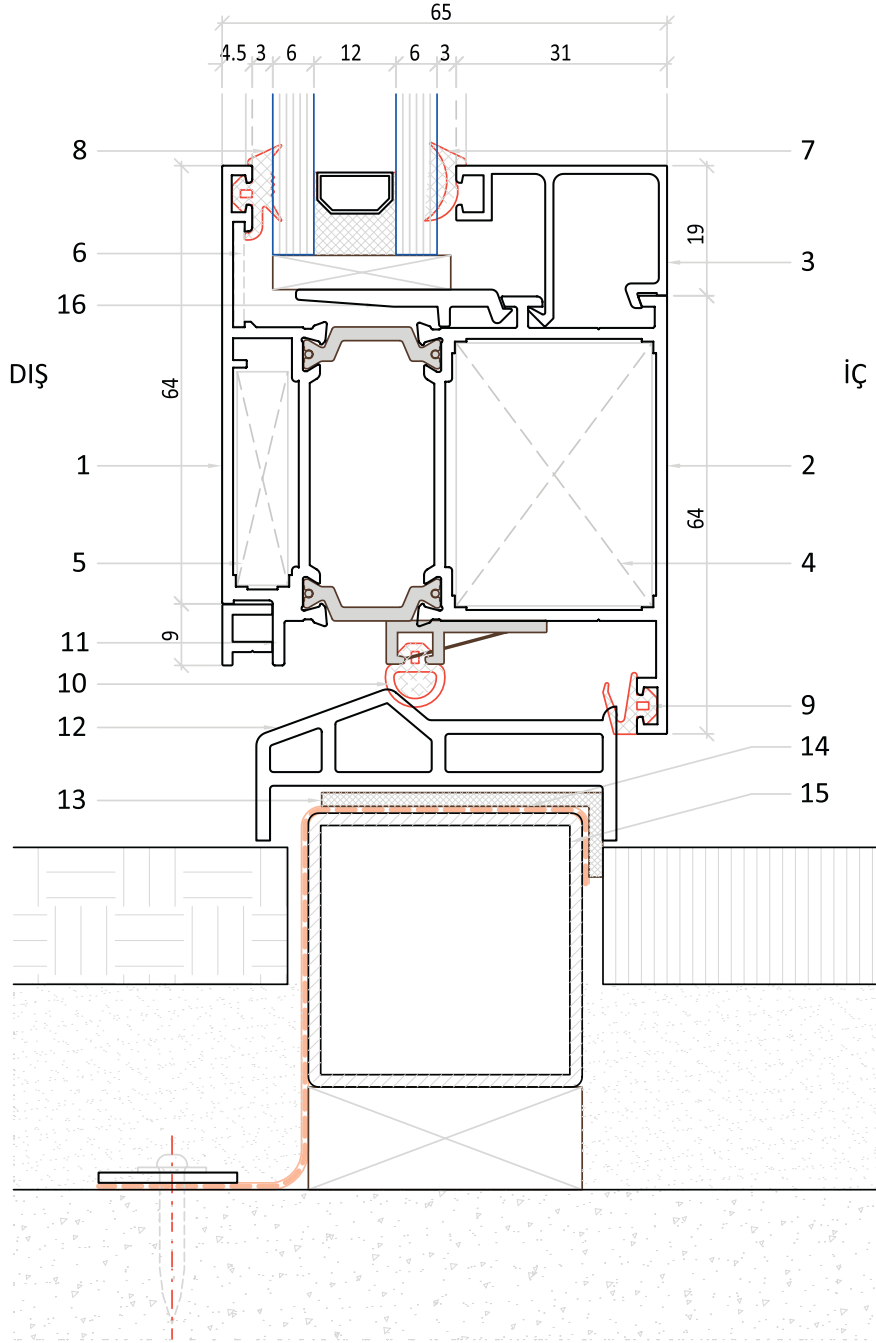

- 1 5815 İÇE-DIŞA KANAT PROFİLİ (DIŞ)
- 2 5814 İÇE-DIŞA KANAT PROFİLİ (İÇ)
- 3 5717 CAM ÇITASI
- 4 5739 KÖŞE TAKOZU
- 5 5738 KÖŞE TAKOZU
- 6 KÖŞE ÇAVUŞU
- 7 4401 EPDM FİTİL (İÇ CAM)
- 8 4400 EPDM FİTİL (DIŞ CAM)

- 9 4403 EPDM FİTİL
- 10 4404 EPDM EŞİK FİTİLİ
- 11 5735 EŞİK PROFİLİ
- 12 5734 EŞİK PROFİLİ
- 13 PVC BANT
- 14 SU YALITIM MEMBRANI
- 15 ÇELİK KÖRKASA
- 16 5719 CAM TAKOZU

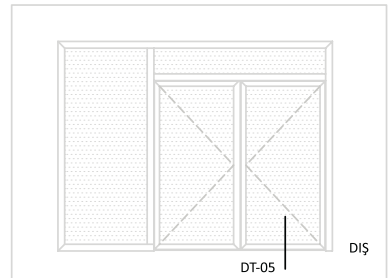

DT-06

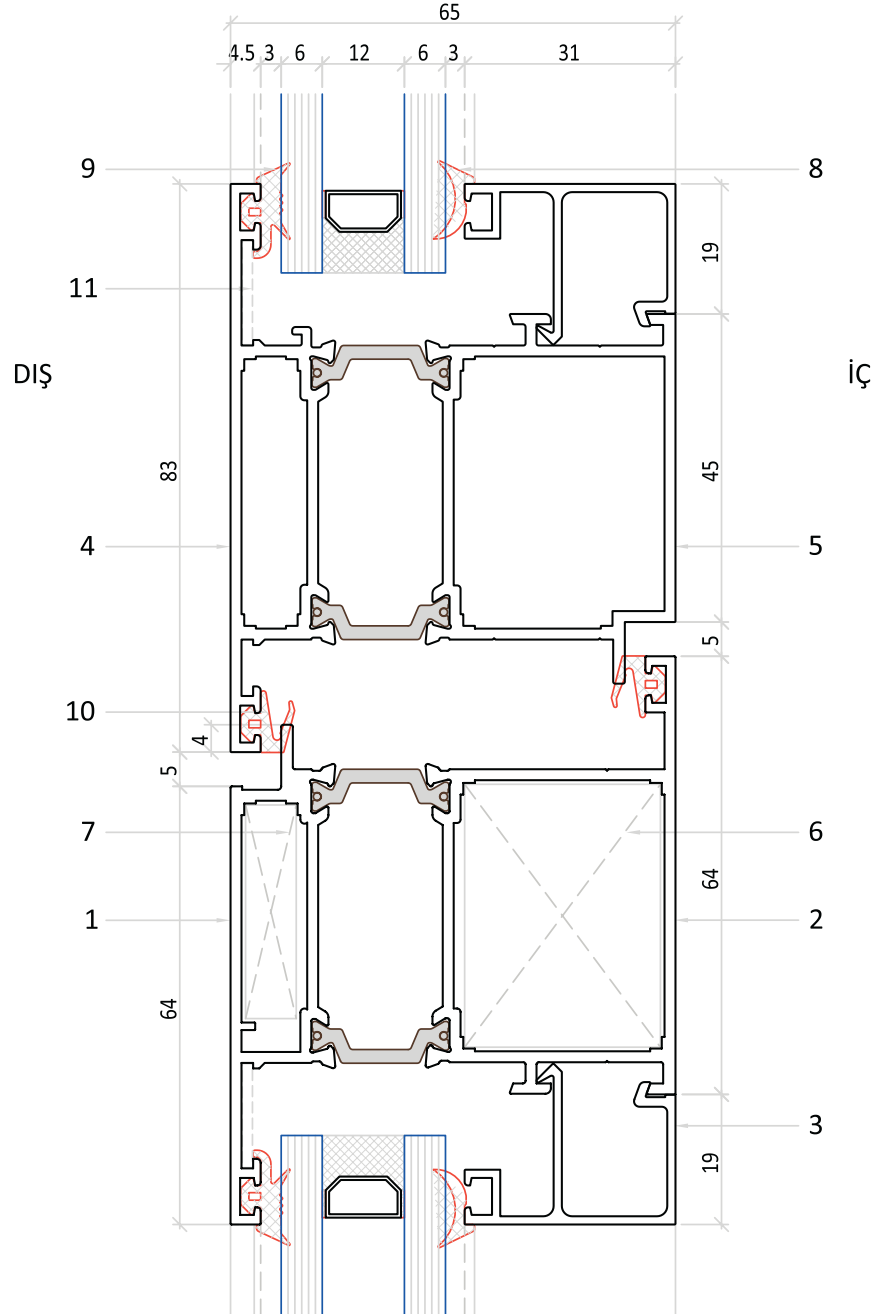

- 1 5815 İÇE-DIŞA KANAT PROFİLİ (DIŞ)
- 2 5814 İÇE-DIŞA KANAT PROFİLİ (İÇ)
- 3 5717 CAM ÇITASI
- 4 5813 İÇE-DIŞA KANAT PROFİLİ (DIŞ)
- 5 5812 İÇE-DIŞA KANAT PROFİLİ (İÇ)
- 6 5739 KÖŞE TAKOZU
- 7 5738 KÖŞE TAKOZU
- 8 4401 EPDM FİTİL (İÇ CAM)

- 9 4400 EPDM FİTİL (DIŞ CAM)
- 10 4403 EPDM FİTİL
- 11 KÖŞE ÇAVUŞU

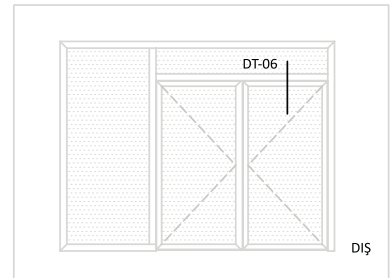

SBW 65 (1,6 mm) ADAPTÖRSÜZ İÇE AÇILIR SİSTEM - TEK KANAT DETAYI



**STARKBAU**  
ALÜMİNYUM PROFİL SİSTEMLERİ



DT-01

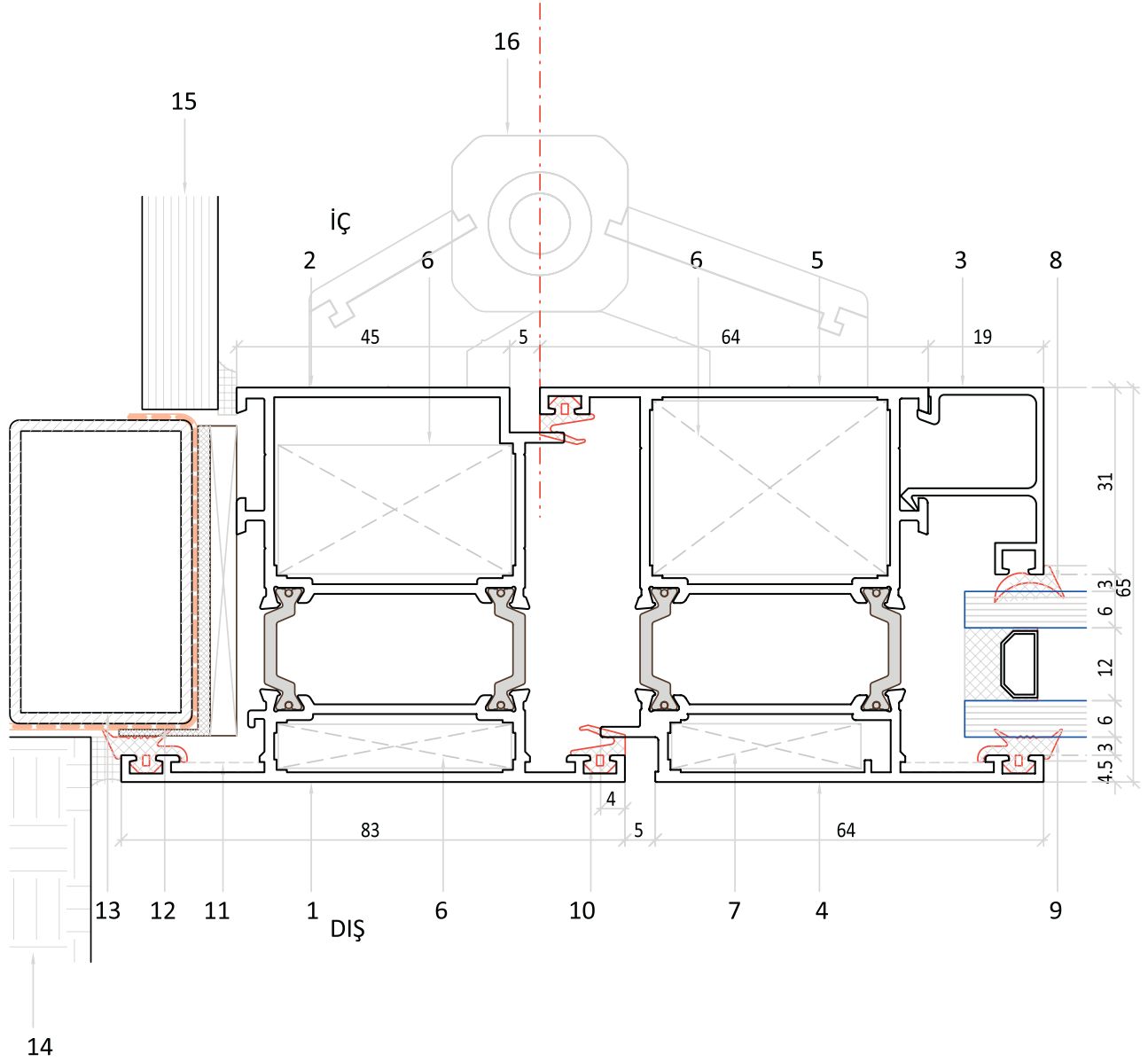

- 1 5813 İÇE-DIŞA KANAT PROFİLİ (DIŞ)
- 2 5812 İÇE-DIŞA KANAT PROFİLİ (İÇ)
- 3 5717 CAM ÇITASI
- 4 5815 İÇE-DIŞA KANAT PROFİLİ (DIŞ)
- 5 5814 İÇE-DIŞA KANAT PROFİLİ (İÇ)
- 6 5739 KÖŞE TAKOZU
- 7 5738 KÖŞE TAKOZU
- 8 4401 EPDM FİTİL (İÇ CAM)

- 9 4400 EPDM FİTİL (DIŞ CAM)
- 10 4403 EPDM FİTİL
- 11 KÖŞE ÇAVUŞU
- 12 SU YALITIM MEMBRANI
- 13 ÇELİK KÖRKASA
- 14 DIŞ KAPLAMA
- 15 İÇ KAPLAMA
- 16 MENTEŞE

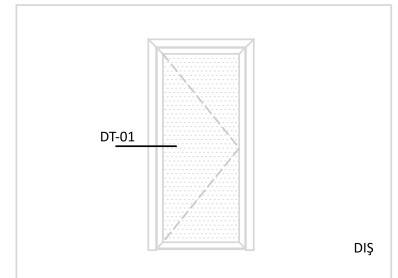

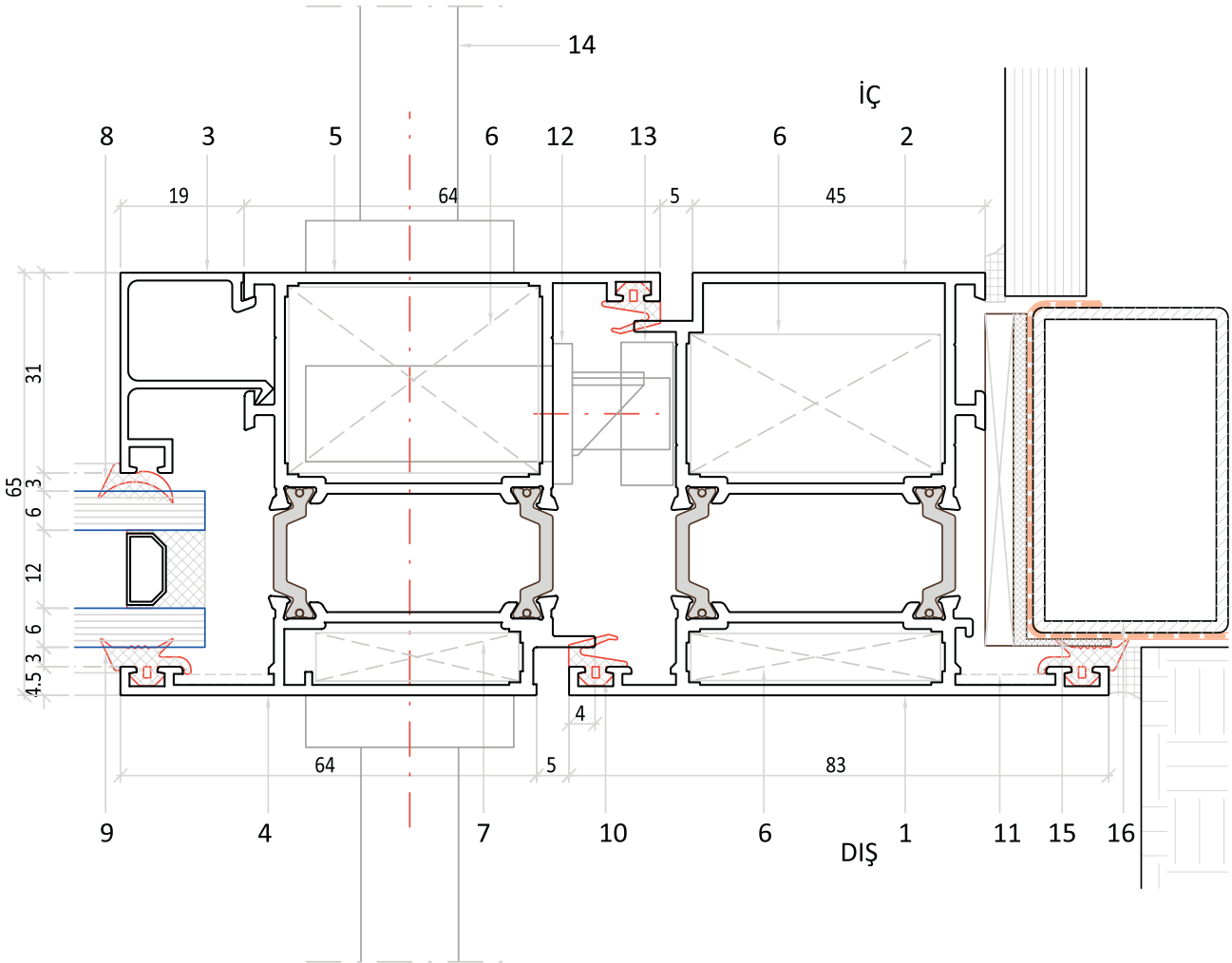

- |   |                                   |
|---|-----------------------------------|
| 1 | 5813 İÇE-DIŞA KANAT PROFİLİ (DIŞ) |
| 2 | 5812 İÇE-DIŞA KANAT PROFİLİ (İÇ)  |
| 3 | 5717 CAM ÇITASI                   |
| 4 | 5815 İÇE-DIŞA KANAT PROFİLİ (DIŞ) |
| 5 | 5814 İÇE-DIŞA KANAT PROFİLİ (İÇ)  |
| 6 | 5739 KÖŞE TAKOZU                  |
| 7 | 5738 KÖŞE TAKOZU                  |
| 8 | 4401 EPDM FİTİL (İÇ CAM)          |

- |    |                           |
|----|---------------------------|
| 9  | 4400 EPDM FİTİL (DIŞ CAM) |
| 10 | 4403 EPDM FİTİL           |
| 11 | KÖŞE ÇAVUŞU               |
| 12 | KİLİT                     |
| 13 | KİLİT KARŞILIĞI           |
| 14 | KOL                       |
| 15 | SU YALITIM MEMBRANI       |
| 16 | ÇELİK KÖRKASA             |

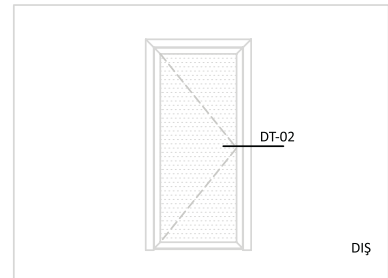

SBW 65 (1,6 mm) ADAPTÖRSÜZ İÇE AÇILIR SİSTEM - TEK KANAT / KANAT ALT BİTİŞ DETAYI

DT-03

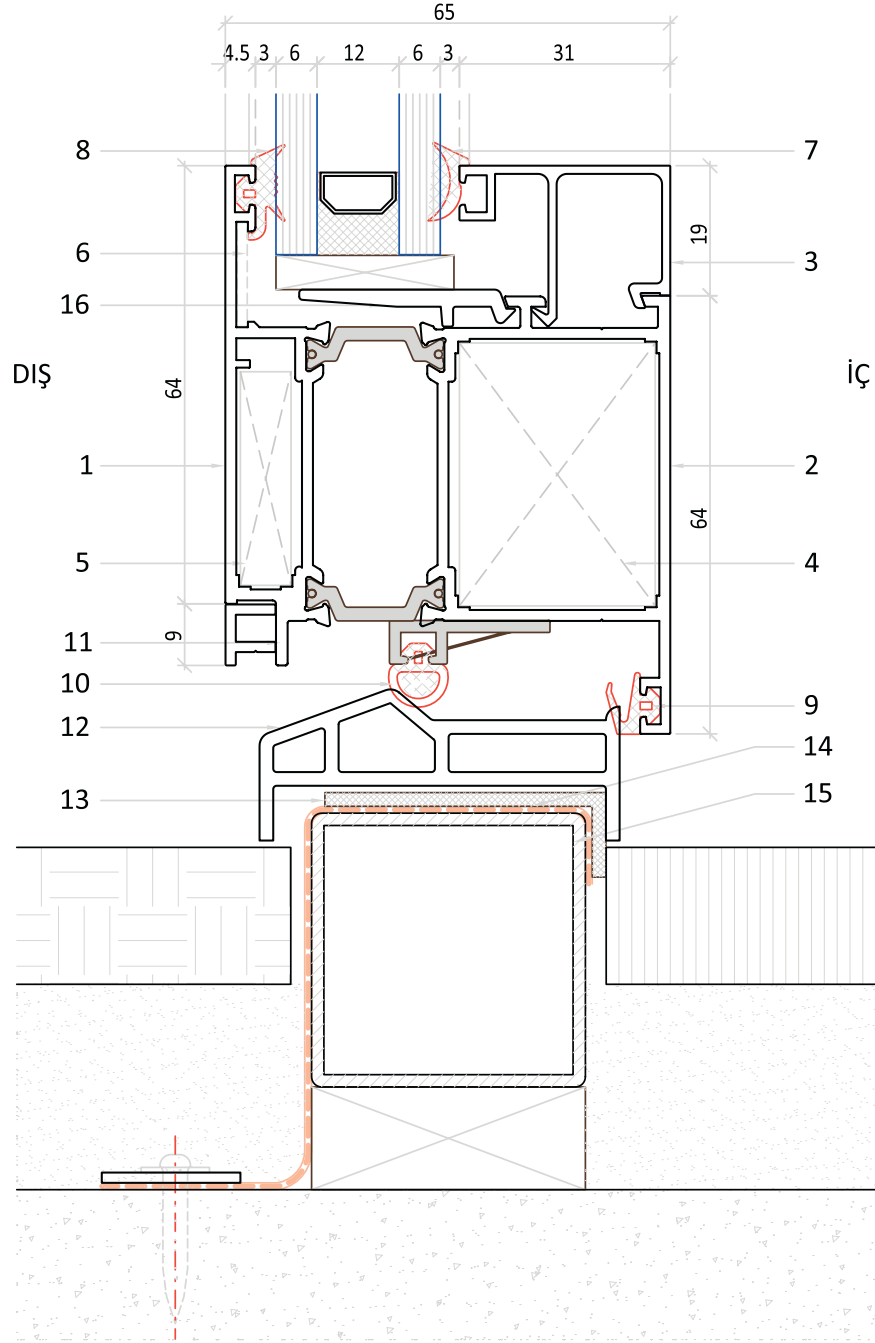

- 1 5815 İÇE-DIŞA KANAT PROFİLİ (DIŞ)
- 2 5814 İÇE-DIŞA KANAT PROFİLİ (İÇ)
- 3 5717 CAM ÇITASI
- 4 5739 KÖŞE TAKOZU
- 5 5738 KÖŞE TAKOZU
- 6 KÖŞE ÇAVUŞU
- 7 4401 EPDM FİTİL (İÇ CAM)
- 8 4400 EPDM FİTİL (DIŞ CAM)

- 9 4403 EPDM FİTİL
- 10 4404 EPDM EŞİK FİTİLİ
- 11 5735 EŞİK PROFİLİ
- 12 5734 EŞİK PROFİLİ
- 13 PVC BANT
- 14 SU YALITIM MEMBRANI
- 15 ÇELİK KÖRKASA
- 16 5719 CAM TAKOZU

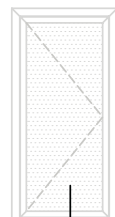

DT-03

DIŞ

SBW 65 (1,6 mm) İÇE AÇILIR SİSTEM - BALKON KAPISI DETAYI



**STARKBAU**  
ALÜMİNYUM PROFİL SİSTEMLERİ

DT-01

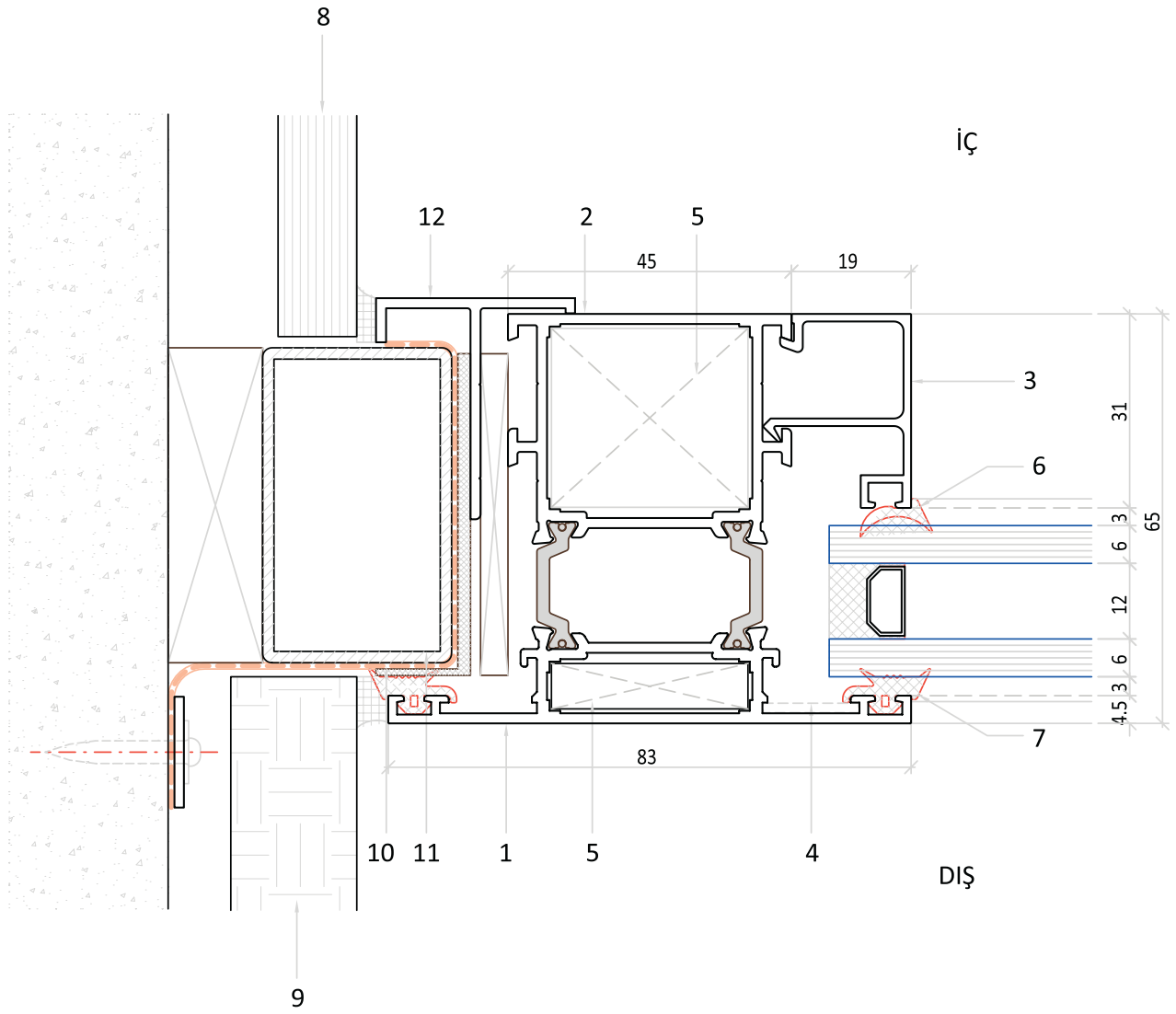

- 1 5807 KASA PROFİLİ (DIŞ)
- 2 5806 KASA PROFİLİ (İÇ)
- 3 5717 CAM ÇİTASI
- 4 KÖŞE ÇAVUŞU
- 5 5738 KÖŞE TAKOZU
- 6 4401 EPDM FİTİL (İÇ CAM)
- 7 4400 EPDM FİTİL (DIŞ CAM)
- 8 İÇ KAPLAMA

- 9 DIŞ KAPLAMA
- 10 SU YALITIM MEMBRANI
- 11 ÇELİK KÖRKASA
- 12 5745 İÇ PEVRAZ

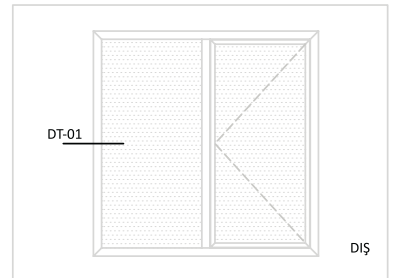

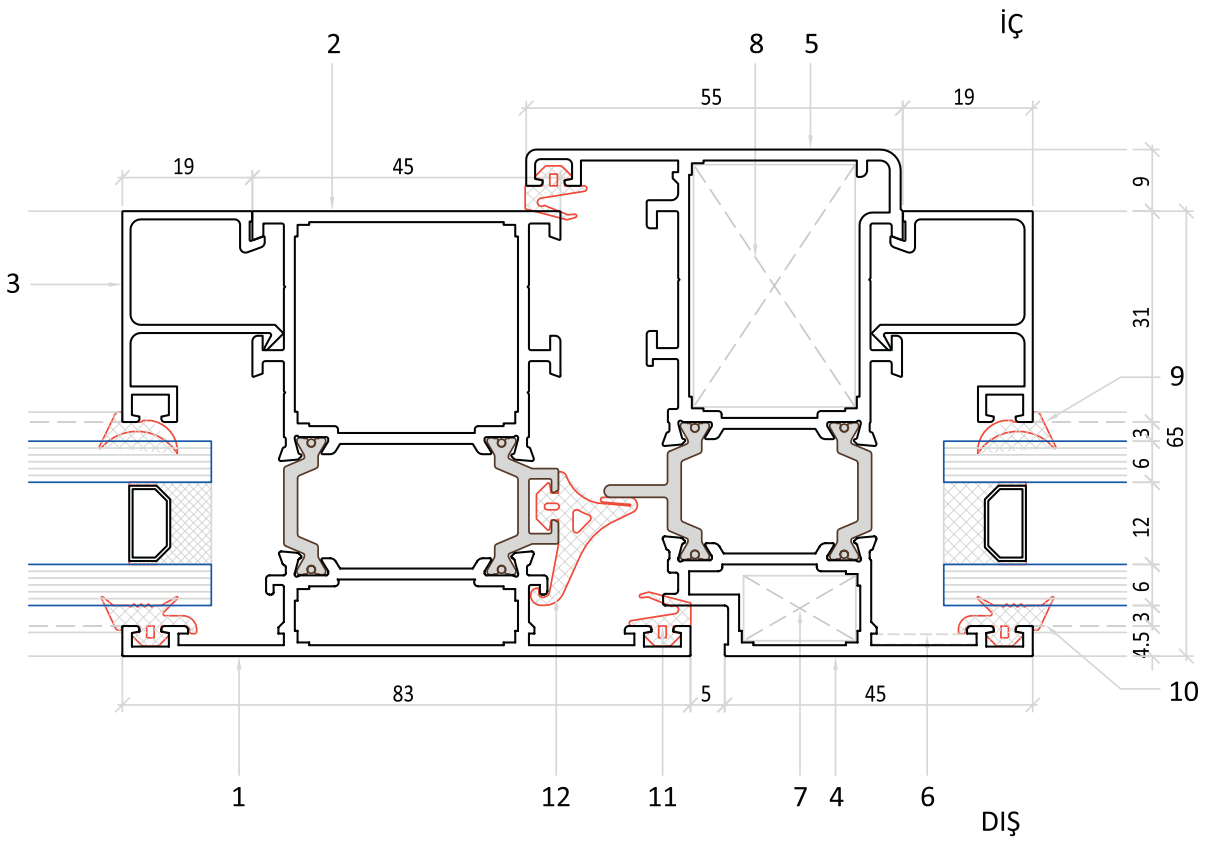

- 1 5807 ORTA KAYIT PROFİLİ (DIŞ)
- 2 5806 ORTA KAYIT PROFİLİ (İÇ)
- 3 5717 CAM ÇITASI
- 4 5809 KANAT PROFİLİ (DIŞ)
- 5 5808 KANAT PROFİLİ (İÇ)
- 6 KÖŞE ÇAVUŞU
- 7 5736 KÖŞE TAKOZU
- 8 5737 KÖŞE TAKOZU

- 9 4401 EPDM FİTİL (İÇ CAM)
- 10 4400 EPDM FİTİL (DIŞ CAM)
- 11 4403 EPDM FİTİL
- 12 4405 KASA-KANAT BİNİ FİTİLİ

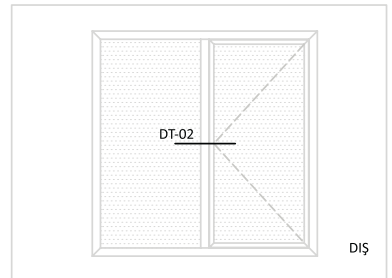

DT-03

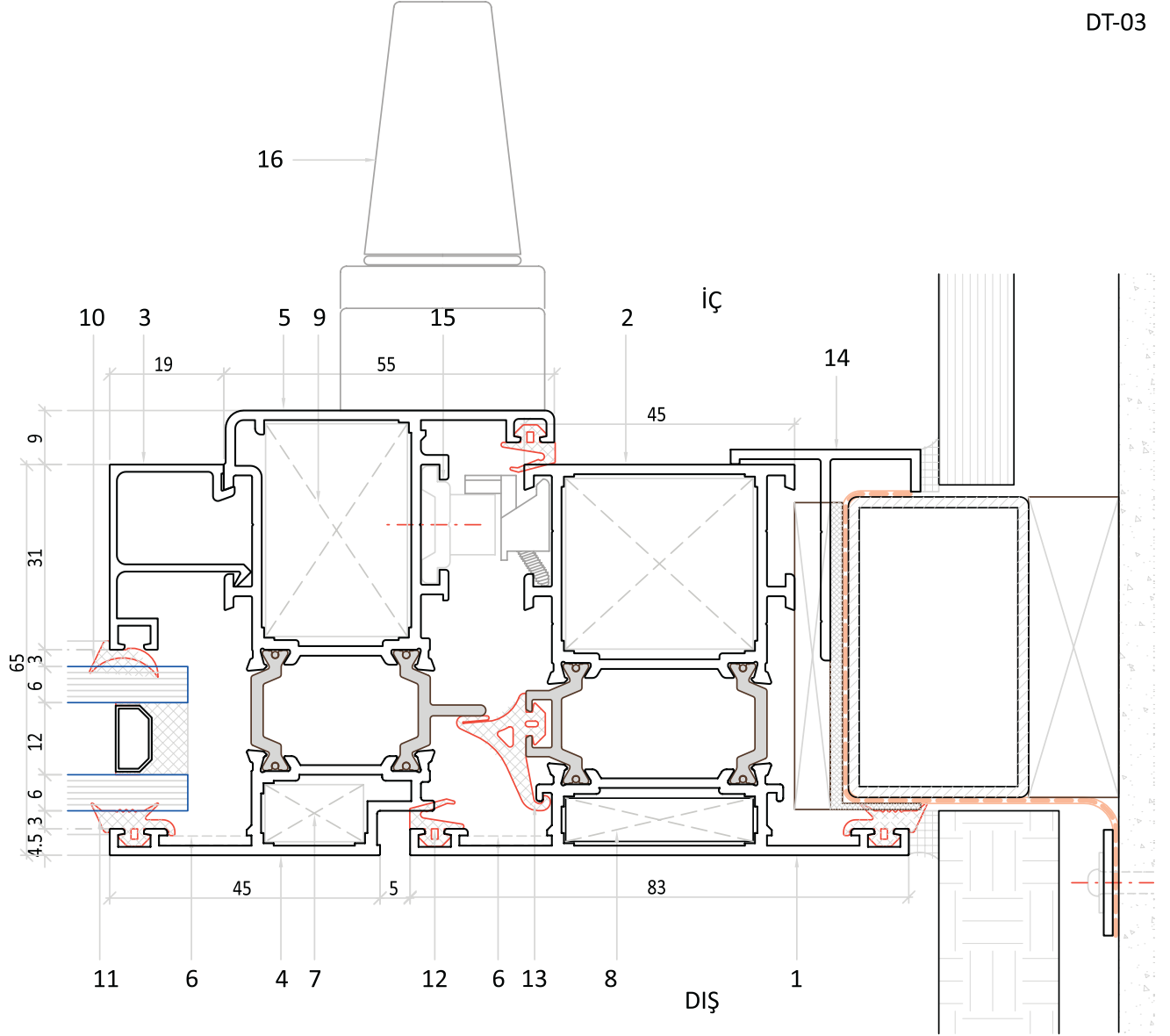

- 1 5807 KASA PROFİLİ (DIŞ)
- 2 5806 KASA PROFİLİ (İÇ)
- 3 5717 CAM ÇİTASI
- 4 5809 KANAT PROFİLİ (DIŞ)
- 5 5808 KANAT PROFİLİ (İÇ)
- 6 KÖŞE ÇAVUŞU
- 7 5736 KÖŞE TAKOZU
- 8 5738 KÖŞE TAKOZU

- 9 5737 KÖŞE TAKOZU
- 10 4401 EPDM FİTİL (İÇ CAM)
- 11 4400 EPDM FİTİL (DIŞ CAM)
- 12 4403 EPDM FİTİL
- 13 4405 KASA-KANAT BİNİ FİTİLİ
- 14 5745 İÇ PERVAZ
- 15 2416 KIZAK PROFİLİ
- 16 KOL

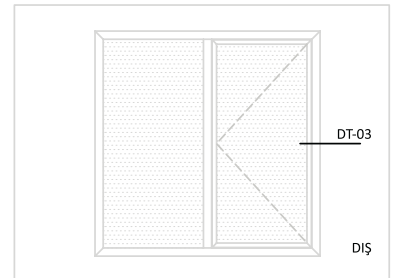

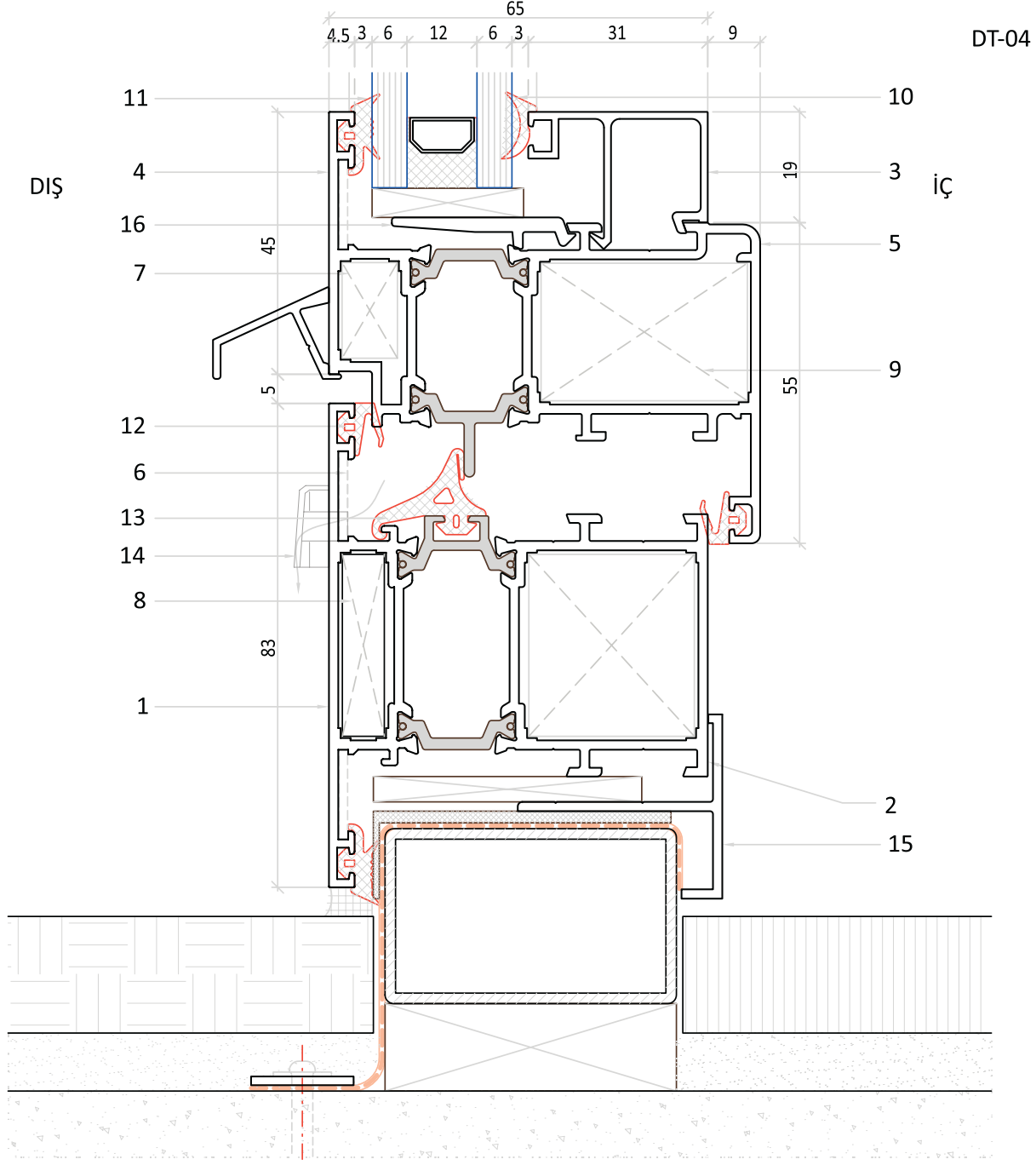

DT-04

DIŞ

İÇ

- 1 5807 KASA PROFİLİ (DIŞ)
- 2 5806 KASA PROFİLİ (İÇ)
- 3 5717 CAM ÇİTASI
- 4 5809 KANAT PROFİLİ (DIŞ)
- 5 5808 KANAT PROFİLİ (İÇ)
- 6 KÖŞE ÇAVUŞU
- 7 5736 KÖŞE TAKOZU
- 8 5738 KÖŞE TAKOZU

- 9 5737 KÖŞE TAKOZU
- 10 4401 EPDM FİTİL (İÇ CAM)
- 11 4400 EPDM FİTİL (DIŞ CAM)
- 12 4403 EPDM FİTİL
- 13 4405 KASA-KANAT BİNİ FİTİLİ
- 14 TAHLİYE KAPAĞI
- 15 5745 İÇ PERVAZ
- 16 5719 CAM TAKOZU

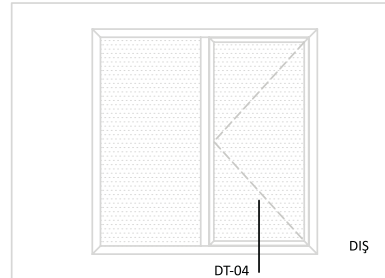

DT-04

DIŞ



SBW 65 (1,6 mm) İÇE AÇILIR SİSTEM - BALKON KAPISI / KANAT - KÖRKASA ÜST BİTİŞ DETAYI

DT-05

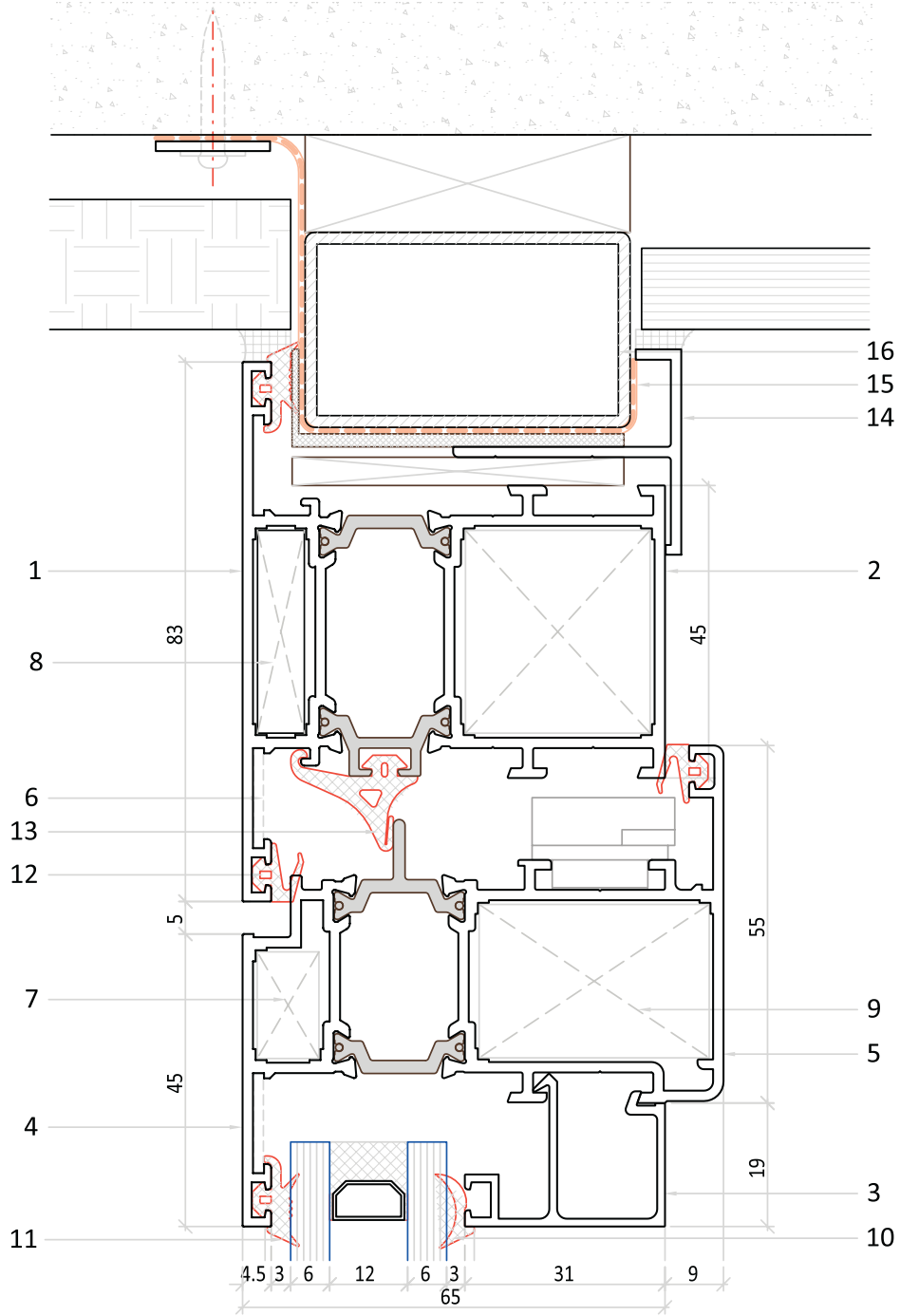

- 1 5807 KASA PROFİLİ (DIŞ)
- 2 5806 KASA PROFİLİ (İÇ)
- 3 5717 CAM ÇİTASI
- 4 5809 KANAT PROFİLİ (DIŞ)
- 5 5808 KANAT PROFİLİ (İÇ)
- 6 KÖŞE ÇAVUŞU
- 7 5736 KÖŞE TAKOZU
- 8 5738 KÖŞE TAKOZU

- 9 5737 KÖŞE TAKOZU
- 10 4401 EPDM FİTİL (İÇ CAM)
- 11 4400 EPDM FİTİL (DIŞ CAM)
- 12 4403 EPDM FİTİL
- 13 4405 KASA-KANAT BİNİ FİTİLİ
- 14 5745 İÇ PERVAZ
- 15 SU YALITIM MEMBRANI
- 16 ÇELİK KÖRKASA

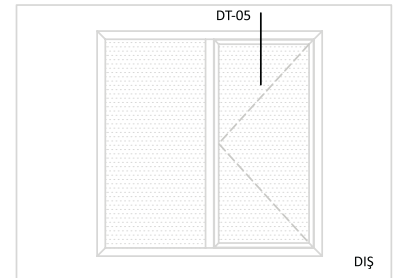

SBW 65 (1,6 mm) KATLANIR KAPI DETAYI

**STARKBAU**  
ALÜMİNYUM PROFİL SİSTEMLERİ

DT-01

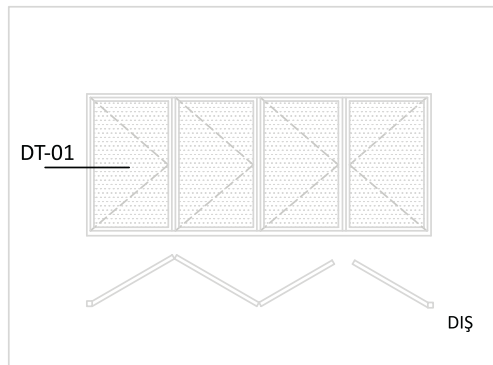
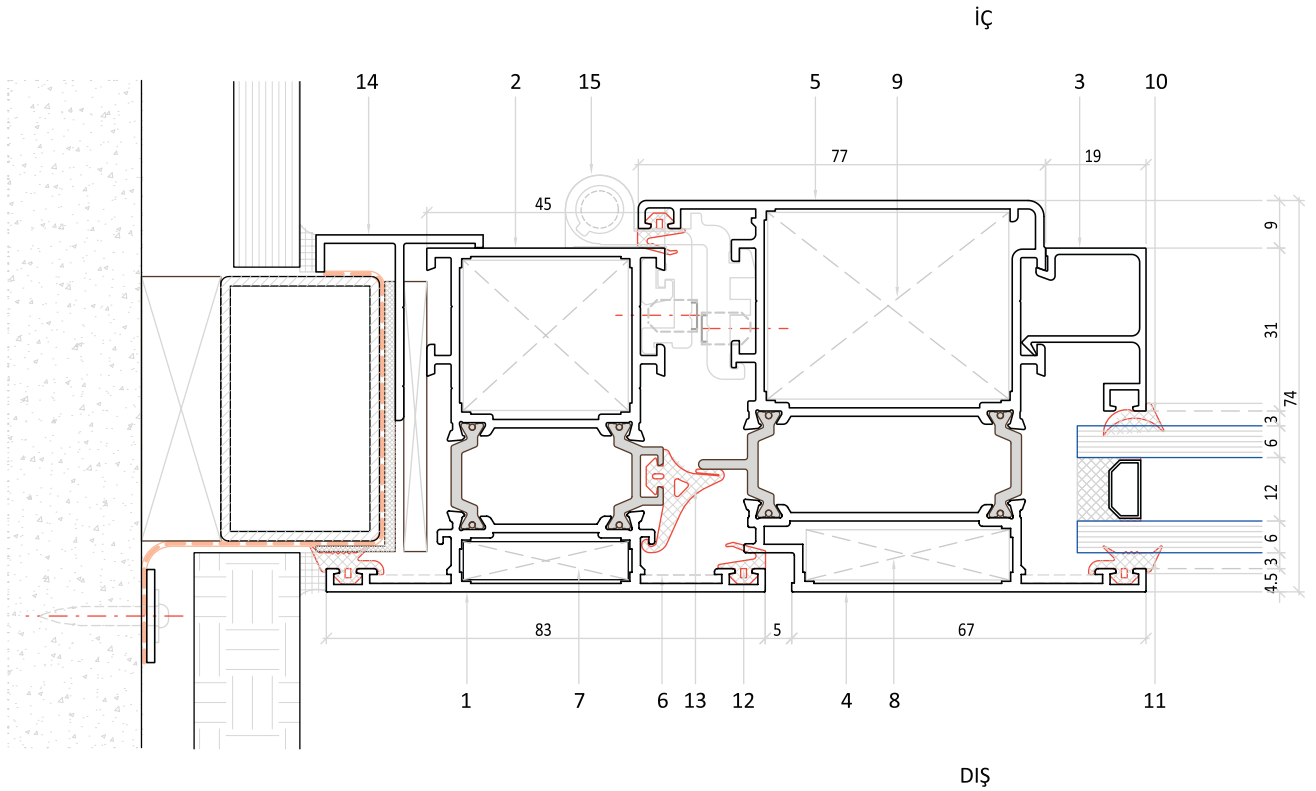

- 1 5807 KASA PROFİLİ (DIŞ)
- 2 5806 KASA PROFİLİ (İÇ)
- 3 5717 CAM ÇITASI
- 4 5811 KANAT PROFİLİ (DIŞ)
- 5 5810 KANAT PROFİLİ (İÇ)
- 6 KÖŞE ÇAVUŞU
- 7 5738 KÖŞE TAKOZU
- 8 5739 KÖŞE TAKOZU

- 9 5740 KÖŞE TAKOZU
- 10 4401 EPDM FİTİL (İÇ CAM)
- 11 4400 EPDM FİTİL (DIŞ CAM)
- 12 4403 EPDM FİTİL
- 13 4405 KASA-KANAT BİNİ FİTİLİ
- 14 5745 İÇ PERVAZ
- 15 MENTEŞE

DT-02

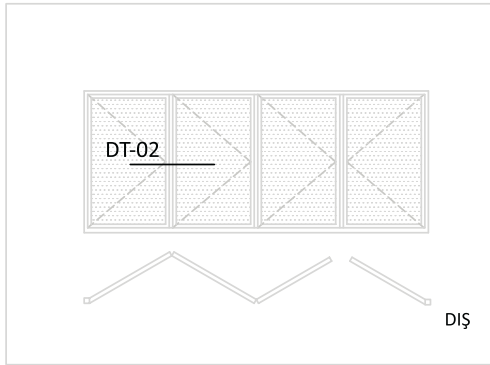
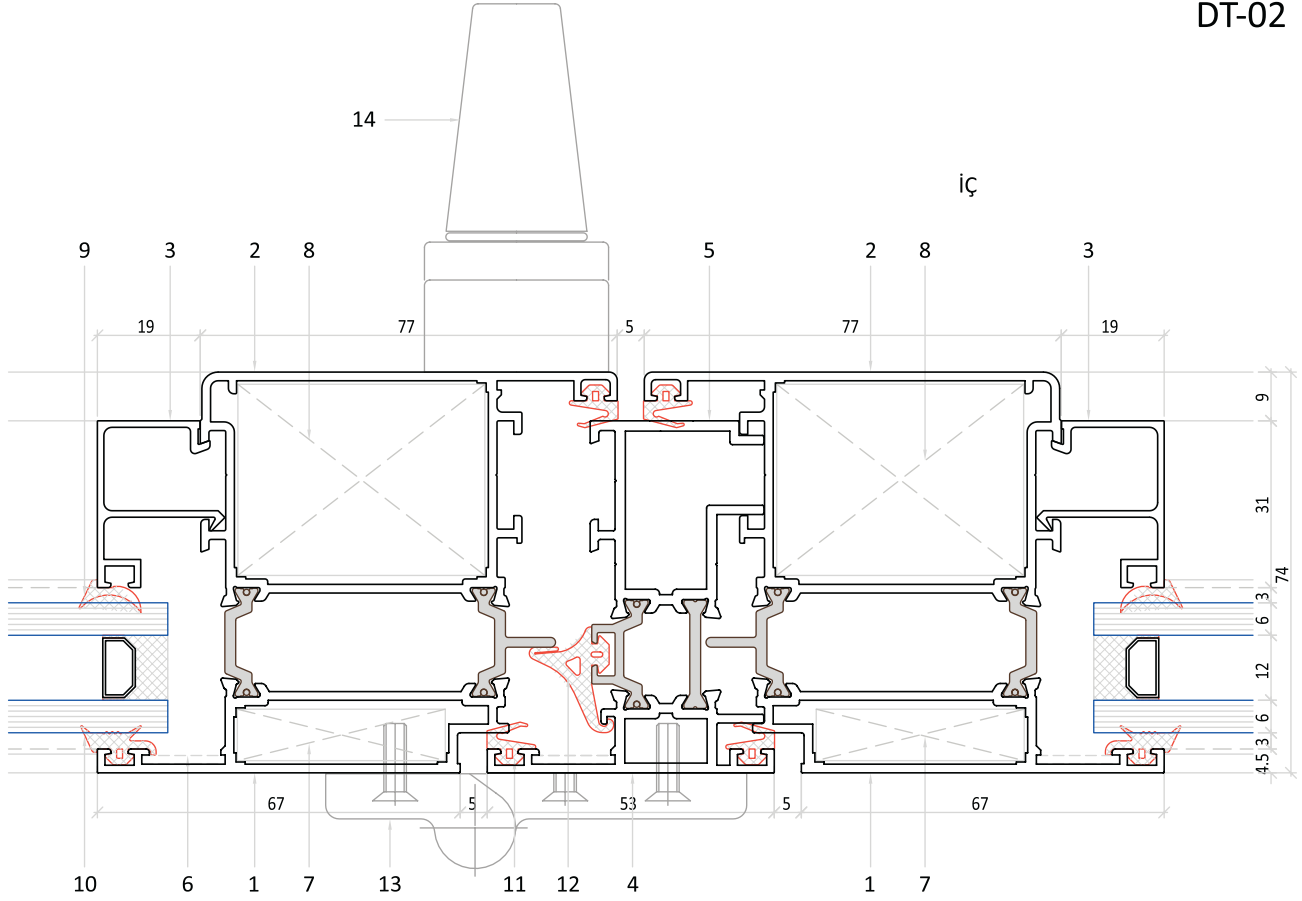

- 1 5811 KANAT PROFİLİ (DİŞ)
- 2 5810 KANAT PROFİLİ (İÇ)
- 3 5717 CAM ÇITASI
- 4 5707 ÇİFT KANAT ADAPTÖRÜ (DİŞ)
- 5 5706 ÇİFT KANAT ADAPTÖRÜ (İÇ)
- 6 KÖŞE ÇAVUŞU
- 7 5739 KÖŞE TAKOZU
- 8 5740 KÖŞE TAKOZU

- 9 4401 EPDM FİTİL (İÇ CAM)
- 10 4400 EPDM FİTİL (DİŞ CAM)
- 11 4403 EPDM FİTİL
- 12 4405 KASA-KANAT BİNİ FİTİLİ
- 13 MENTEŞE
- 14 KOL

DT-03

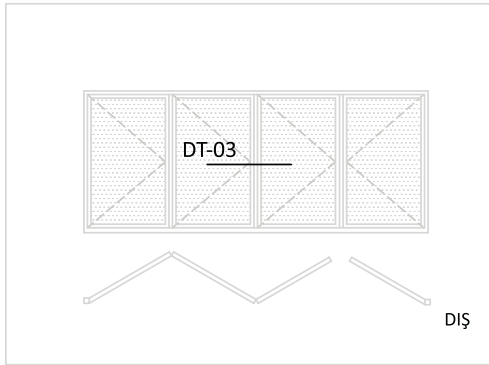
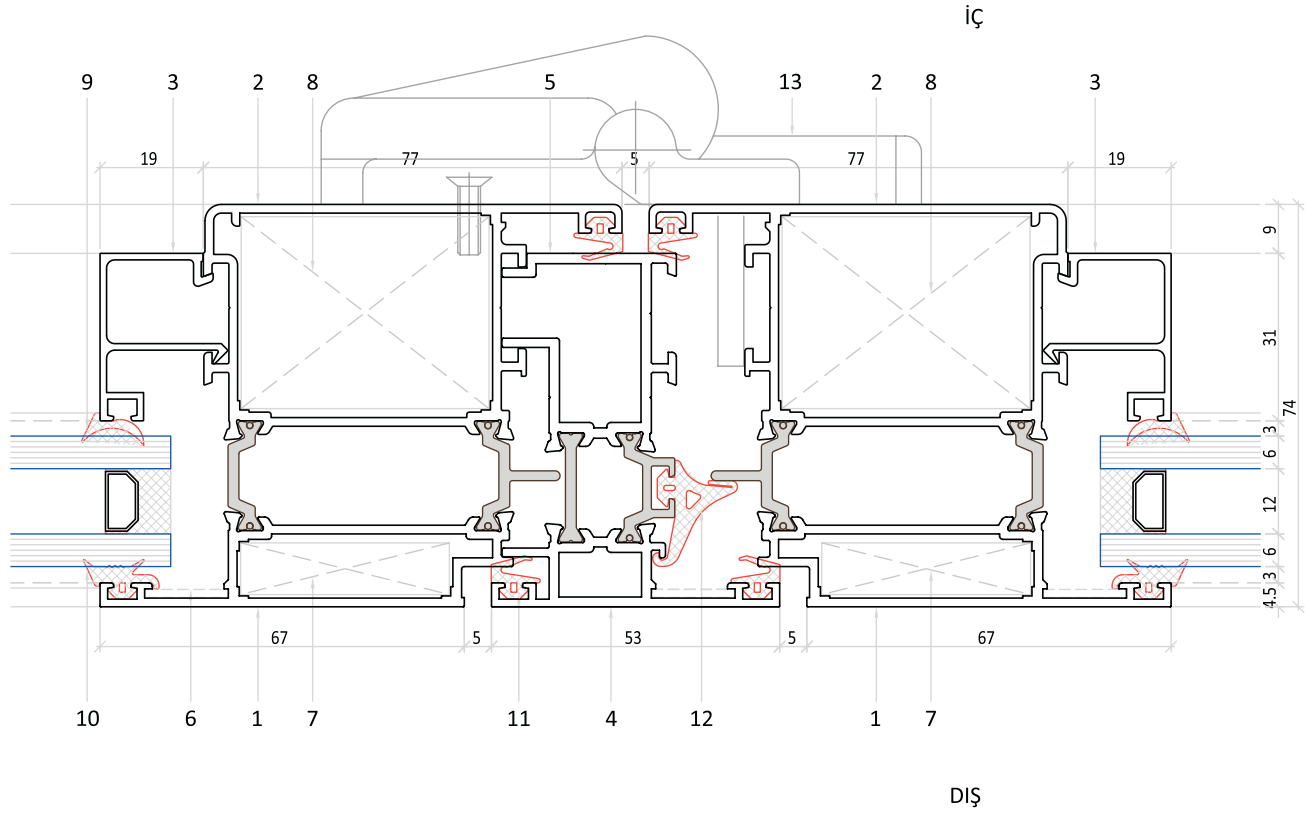

- 1 5811 KANAT PROFİLİ (DIŞ)
- 2 5810 KANAT PROFİLİ (İÇ)
- 3 5717 CAM ÇITASI
- 4 5707 ÇİFT KANAT ADAPTÖRÜ (DIŞ)
- 5 5706 ÇİFT KANAT ADAPTÖRÜ (İÇ)
- 6 KÖŞE ÇAVUŞU
- 7 5739 KÖŞE TAKOZU
- 8 5740 KÖŞE TAKOZU

- 9 4401 EPDM FİTİL (İÇ CAM)
- 10 4400 EPDM FİTİL (DIŞ CAM)
- 11 4403 EPDM FİTİL
- 12 4405 KASA-KANAT BİNİ FİTİLİ
- 13 MENTEŞE

DT-04

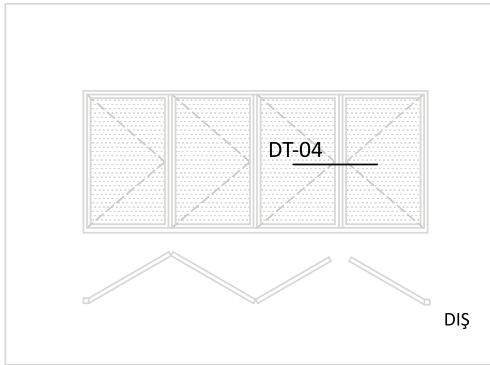
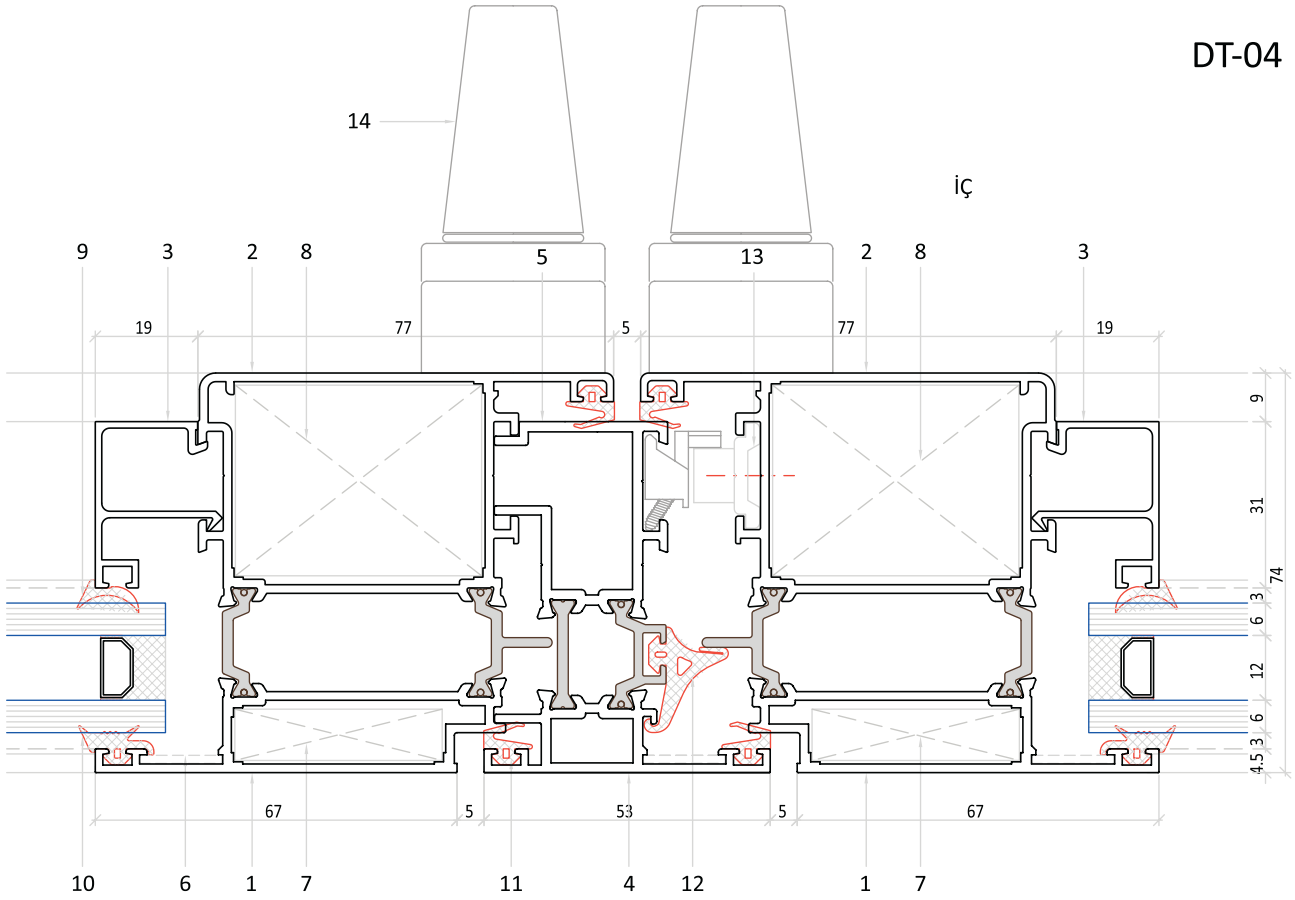

- 1 5811 KANAT PROFİLİ (DİŞ)
- 2 5810 KANAT PROFİLİ (İÇ)
- 3 5717 CAM ÇITASI
- 4 5707 ÇİFT KANAT ADAPTÖRÜ (DİŞ)
- 5 5706 ÇİFT KANAT ADAPTÖRÜ (İÇ)
- 6 KÖŞE ÇAVUŞU
- 7 5739 KÖŞE TAKOZU
- 8 5740 KÖŞE TAKOZU

- 9 4401 EPDM FİTİL (İÇ CAM)
- 10 4400 EPDM FİTİL (DİŞ CAM)
- 11 4403 EPDM FİTİL
- 12 4405 KASA-KANAT BİNİ FİTİLİ
- 13 2416 KIZAK PROFİLİ
- 14 KOL

DT-05

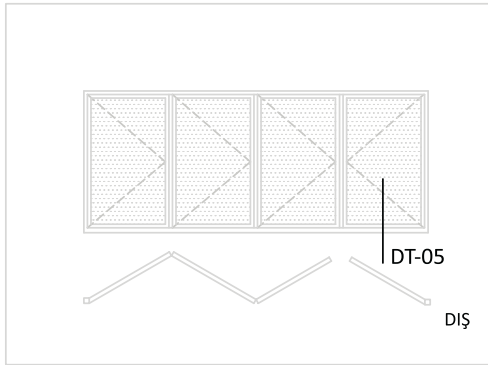
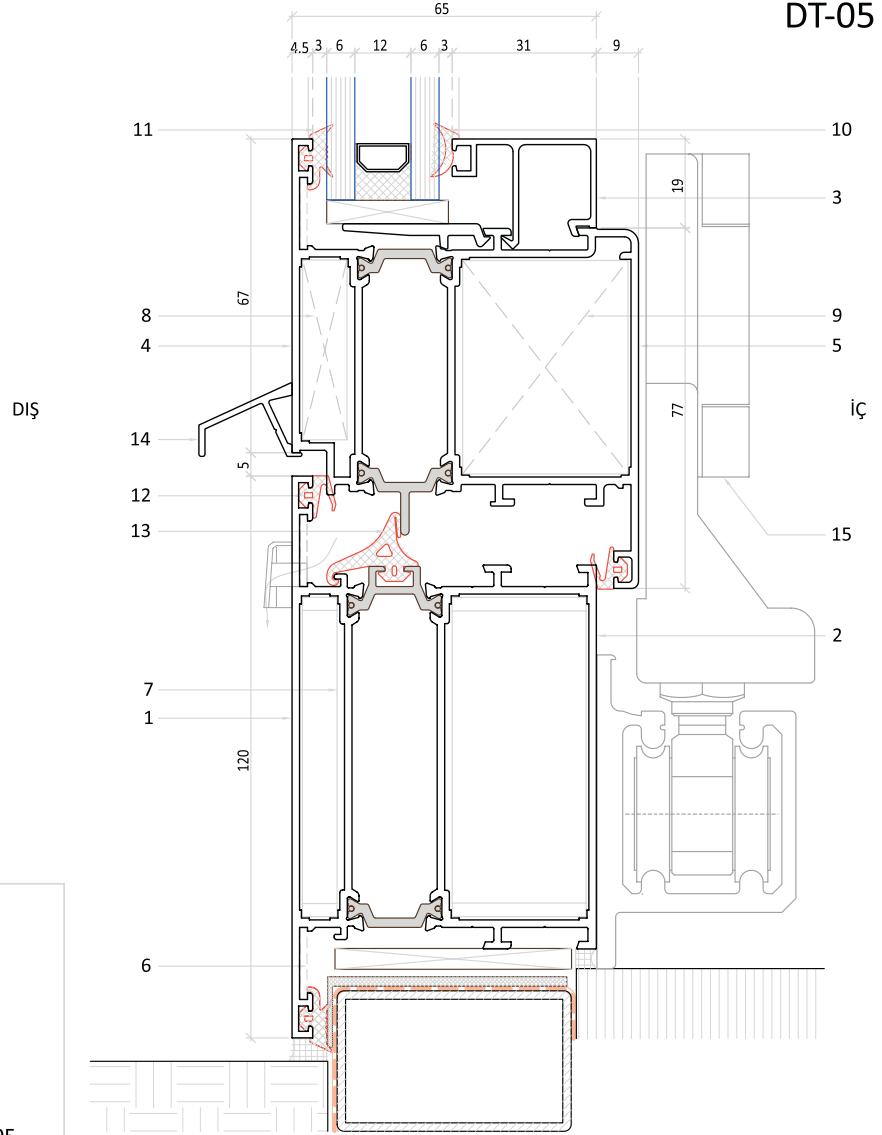

- 1 5816 GENİŞ KASA PROFİLİ (DIŞ)
- 2 5817 GENİŞ KASA PROFİLİ (İÇ)
- 3 5717 CAM ÇITASI
- 4 5811 KANAT PROFİLİ (DIŞ)
- 5 5810 KANAT PROFİLİ (İÇ)
- 6 KÖŞE ÇAVUŞU
- 7 5742 U ÇEKTİRME PROFİLİ
- 8 5739 KÖŞE TAKOZU

- 9 5740 KÖŞE TAKOZU
- 10 4401 EPDM FİTİL (İÇ CAM)
- 11 4400 EPDM FİTİL (DIŞ CAM)
- 12 4403 EPDM FİTİL
- 13 4405 KASA-KANAT BİNİ FİTİLİ
- 14 5720 DAMLALIK
- 15 KATLANIR KAPI MEKANİZMASI

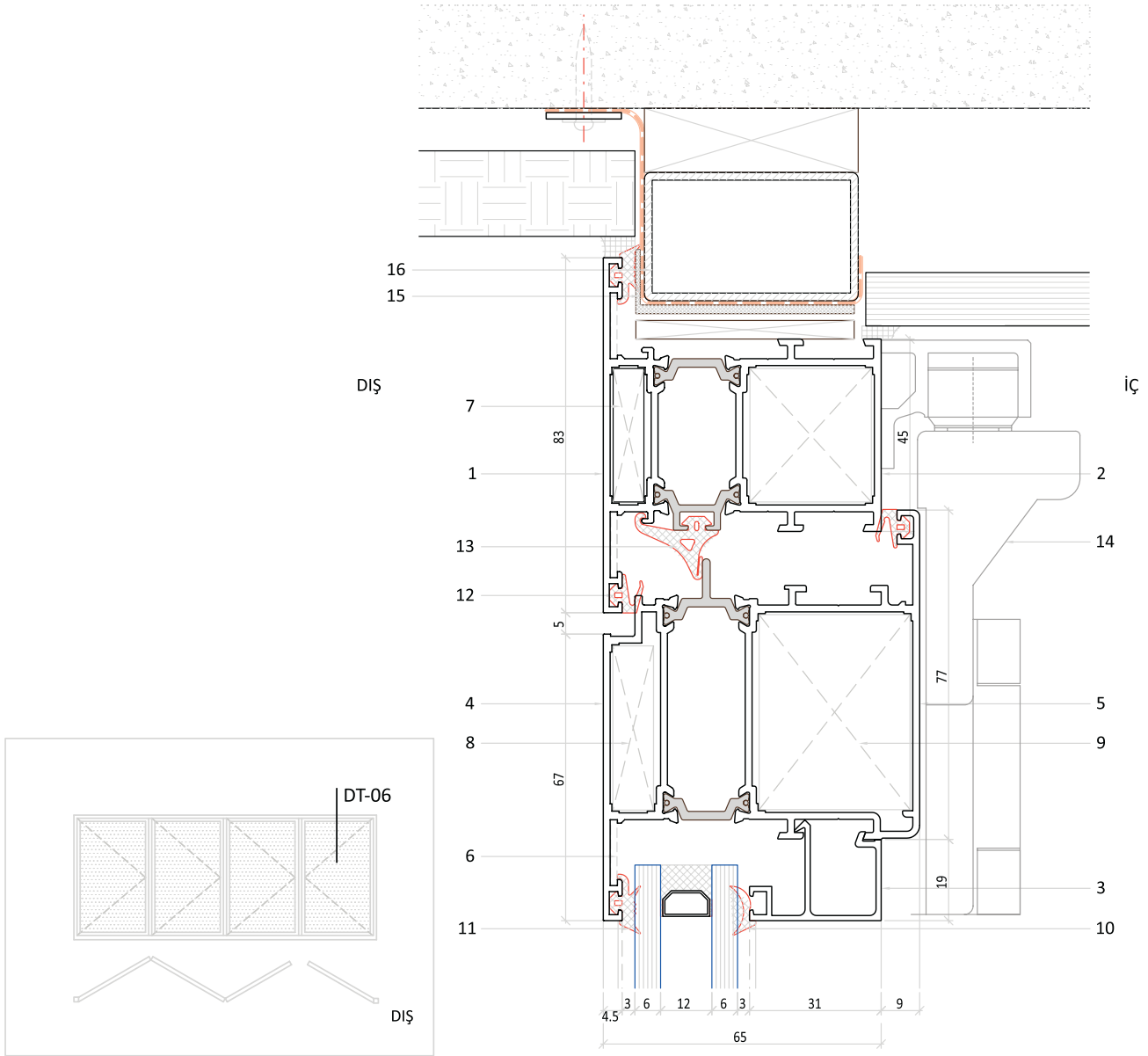

- 1 5807 KASA PROFİLİ (DIŞ)
- 2 5806 KASA PROFİLİ (İÇ)
- 3 5717 CAM ÇITASI
- 4 5811 KANAT PROFİLİ (DIŞ)
- 5 5810 KANAT PROFİLİ (İÇ)
- 6 KÖŞE ÇAVUŞU
- 7 5738 KÖŞE TAKOZU
- 8 5739 KÖŞE TAKOZU

- 9 5740 KÖŞE TAKOZU
- 10 4401 EPDM FİTİL (İÇ CAM)
- 11 4400 EPDM FİTİL (DIŞ CAM)
- 12 4403 EPDM FİTİL
- 13 4405 KASA-KANAT BİNİ FİTİLİ
- 14 KATLANIR KAPI MEKANİZMASI
- 15 SU YALITIM MEMBRANI
- 16 ÇELİK KÖRKASA



SBW 65 (1,6 mm) SÜRME SİSTEM - VASİSTAS PENCERE DETAYI



**STARKBAU**  
ALÜMİNYUM PROFİL SİSTEMLERİ

DT-01

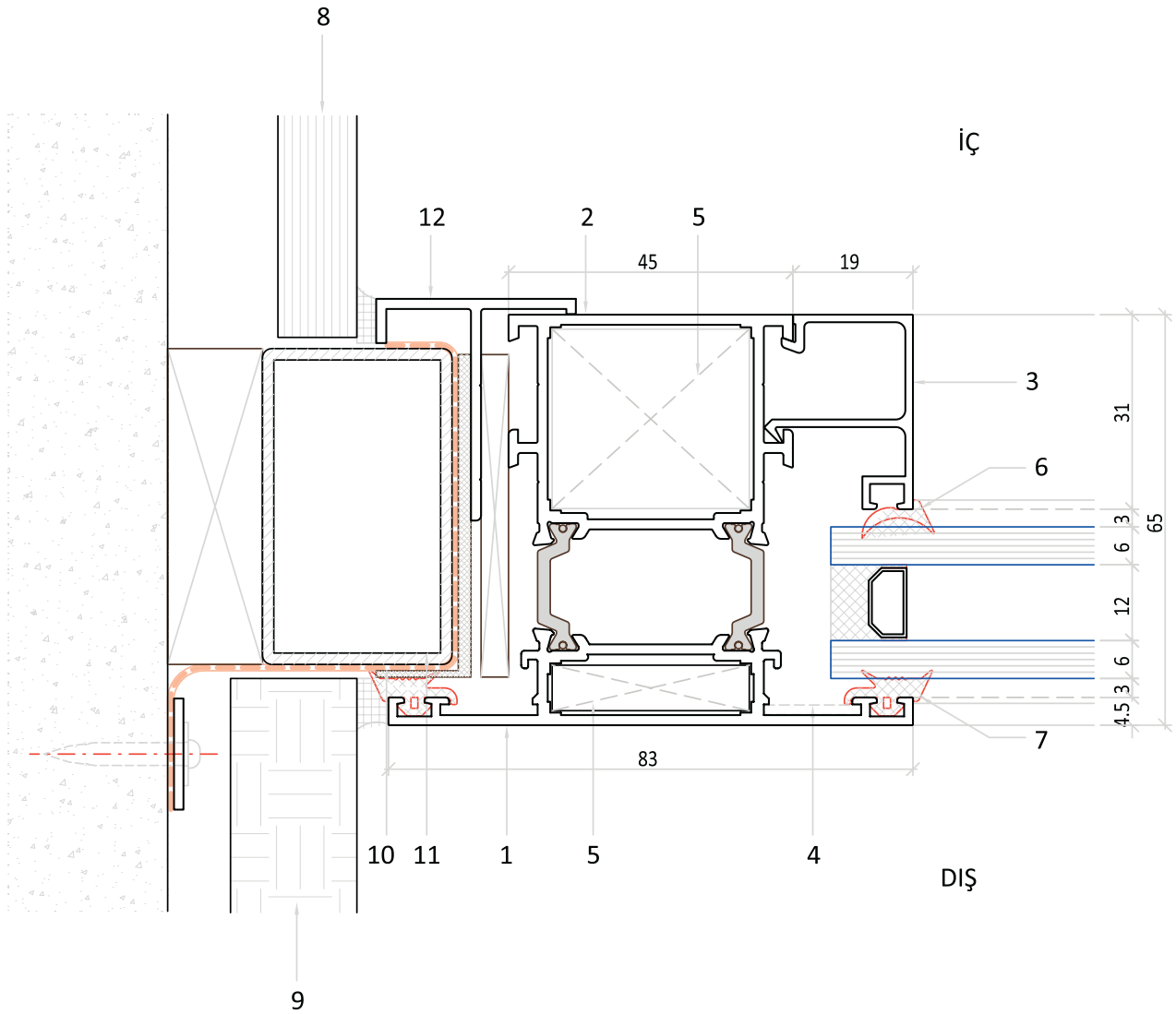

- 1 5807 KASA PROFİLİ (DIŞ)
- 2 5806 KASA PROFİLİ (İÇ)
- 3 5717 CAM ÇITASI
- 4 KÖŞE ÇAVUŞU
- 5 5738 KÖŞE TAKOZU
- 6 4401 EPDM FİTİL (İÇ CAM)
- 7 4400 EPDM FİTİL (DIŞ CAM)
- 8 İÇ KAPLAMA

- 9 DIŞ KAPLAMA
- 10 SU YALITIM MEMBRANI
- 11 ÇELİK KÖRKASA
- 12 5745 İÇ PERVAZ

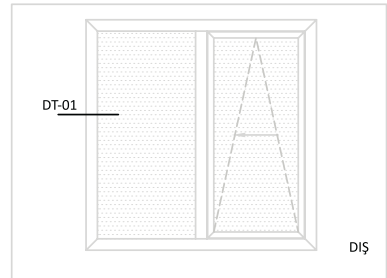

DT-02

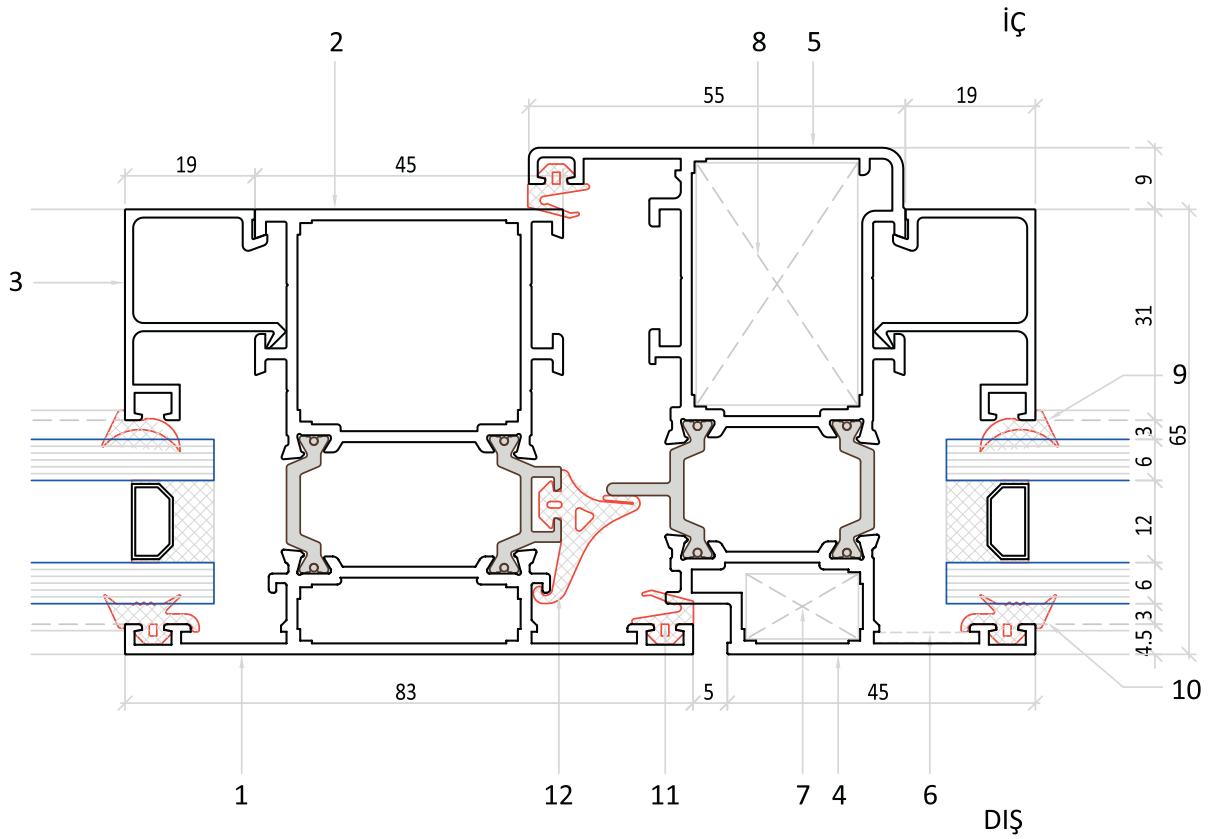

- 1 5807 ORTA KAYIT PROFİLİ (DIŞ)
- 2 5806 KASA PROFİLİ (İÇ)
- 3 5717 CAM ÇITASI
- 4 5809 KANAT PROFİLİ (DIŞ)
- 5 5808 KANAT PROFİLİ (İÇ)
- 6 KÖŞE ÇAVUŞU
- 7 5736 KÖŞE TAKOZU
- 8 5737 KÖŞE TAKOZU

- 9 4401 EPDM FİTİL (İÇ CAM)
- 10 4400 EPDM FİTİL (DIŞ CAM)
- 11 4403 EPDM FİTİL
- 12 4405 KASA-KANAT BİNİ FİTİLİ

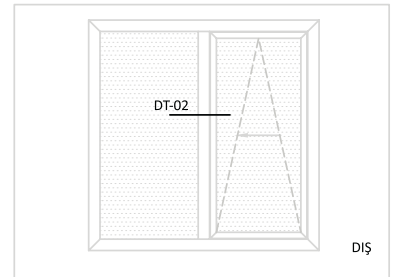

DT-03

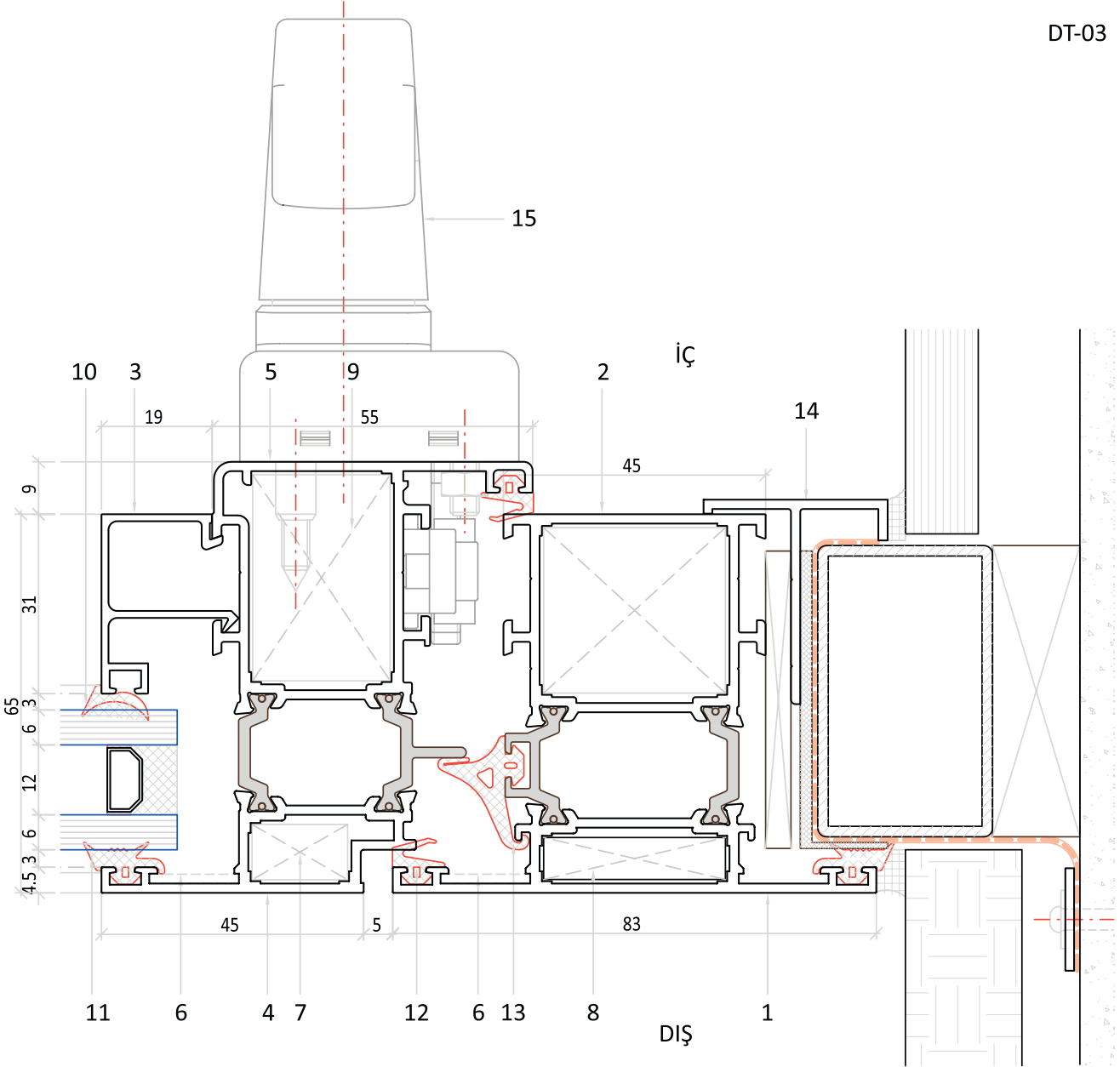

- 1 5807 KASA PROFİLİ (DIŞ)
- 2 5806 KASA PROFİLİ (İÇ)
- 3 5717 CAM ÇITASI
- 4 5809 KANAT PROFİLİ (DIŞ)
- 5 5808 KANAT PROFİLİ (İÇ)
- 6 KÖŞE ÇAVUŞU
- 7 5736 KÖŞE TAKOZU
- 8 5738 KÖŞE TAKOZU

- 9 5737 KÖŞE TAKOZU
- 10 4401 EPDM FİTİL (İÇ CAM)
- 11 4400 EPDM FİTİL (DIŞ CAM)
- 12 4403 EPDM FİTİL
- 13 4405 KASA-KANAT BİNİ FİTİLİ
- 14 5745 İÇ PERVAZ
- 15 KOL

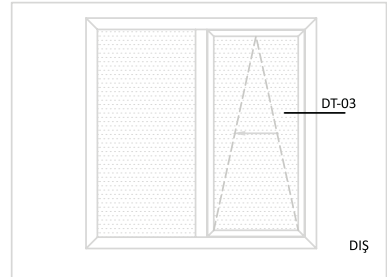

SBW 65 (1,6 mm) SÜRME SİSTEM - VASİSTAS PENCERE / KANAT - ALT BİTİŞ DETAYI

DT-04

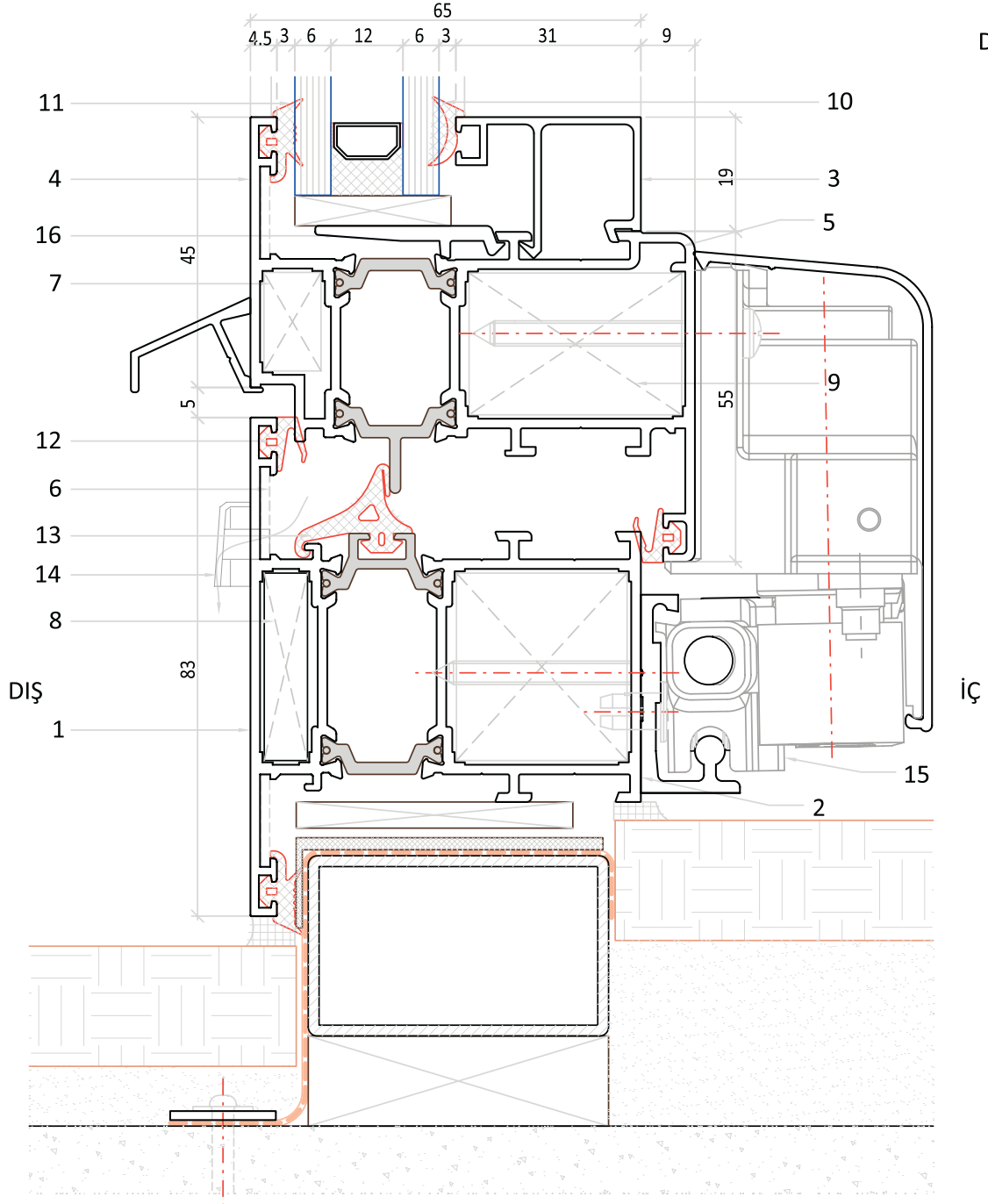

- 1 5807 KASA PROFİLİ (DIŞ)
- 2 5806 KASA PROFİLİ (İÇ)
- 3 5717 CAM ÇİTASI
- 4 5809 KANAT PROFİLİ (DIŞ)
- 5 5808 KANAT PROFİLİ (İÇ)
- 6 KÖŞE ÇAVUŞU
- 7 5736 KÖŞE TAKOZU
- 8 5738 KÖŞE TAKOZU

- 9 5737 KÖŞE TAKOZU
- 10 4401 EPDM FİTİL (İÇ CAM)
- 11 4400 EPDM FİTİL (DIŞ CAM)
- 12 4403 EPDM FİTİL
- 13 4405 KASA-KANAT BİNİ FİTİLİ
- 14 TAHLİYE KAPAĞI
- 15 SÜRME-VASİSTAS MEKANİZMA
- 16 5719 CAM TAKOZU

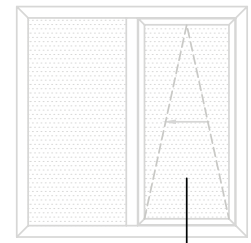

DT-05

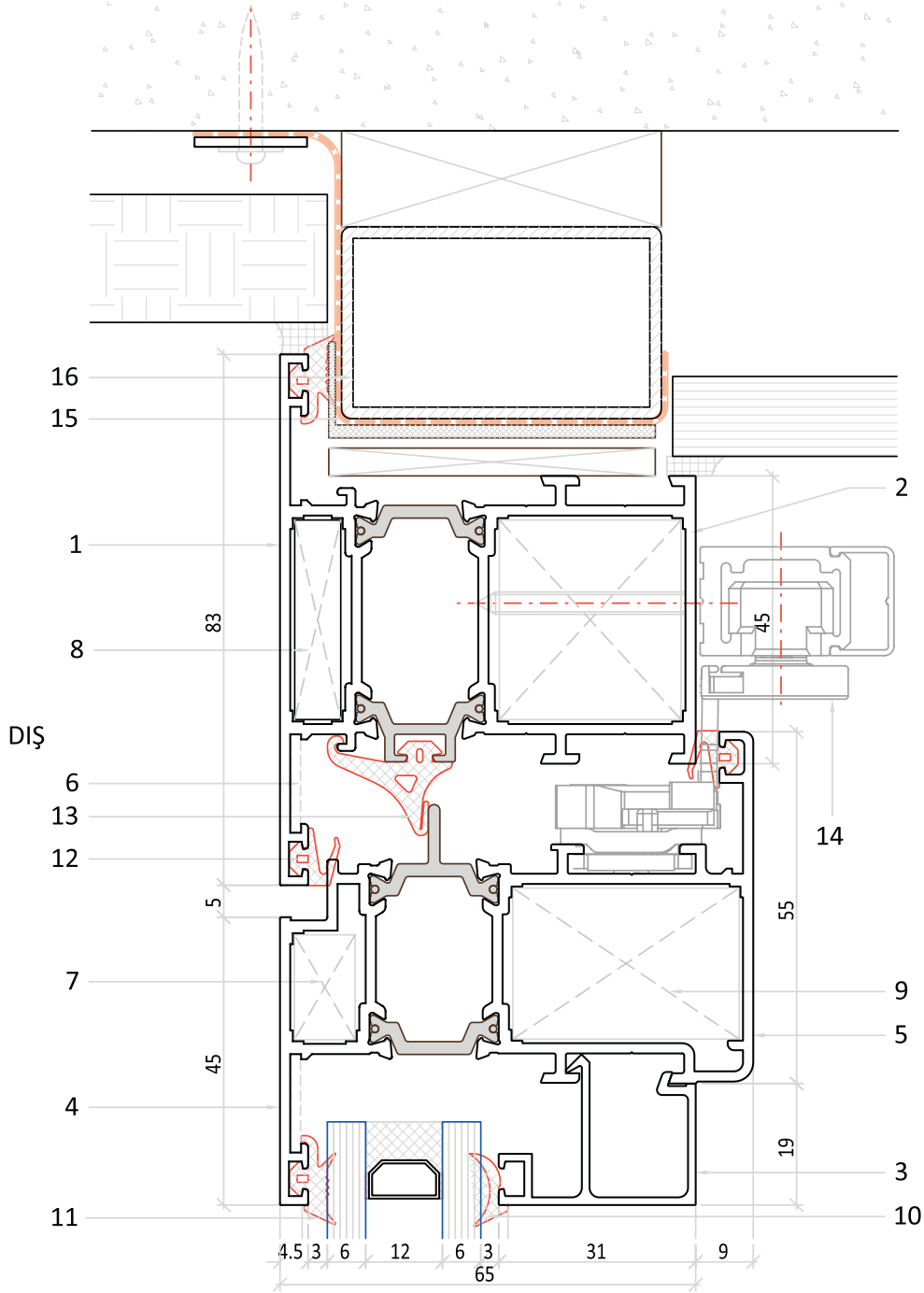

- 1 5807 KASA PROFİLİ (DIŞ)
- 2 5806 KASA PROFİLİ (İÇ)
- 3 5717 CAM ÇİTASI
- 4 5809 KANAT PROFİLİ (DIŞ)
- 5 5808 KANAT PROFİLİ (İÇ)
- 6 KÖŞE ÇAVUŞU
- 7 5736 KÖŞE TAKOZU
- 8 5738 KÖŞE TAKOZU

- 9 5737 KÖŞE TAKOZU
- 10 4401 EPDM FİTİL (İÇ CAM)
- 11 4400 EPDM FİTİL (DIŞ CAM)
- 12 4403 EPDM FİTİL
- 13 4405 KASA-KANAT BİNİ FİTİLİ
- 14 SÜRME-VASİSTAS MEKANİZMA
- 15 SU YALITIM MEMBRANI
- 16 ÇELİK KÖRKASA

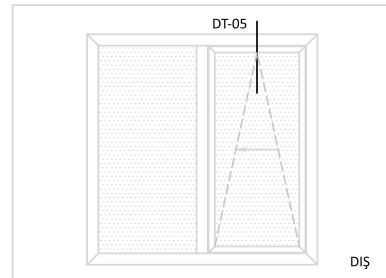

SBW 65 (1,6 mm) PENCERE - İÇE AÇILIR SİSTEM DETAYI



**STARKBAU**  
ALÜMİNYUM PROFİL SİSTEMLERİ

DT-01(1)

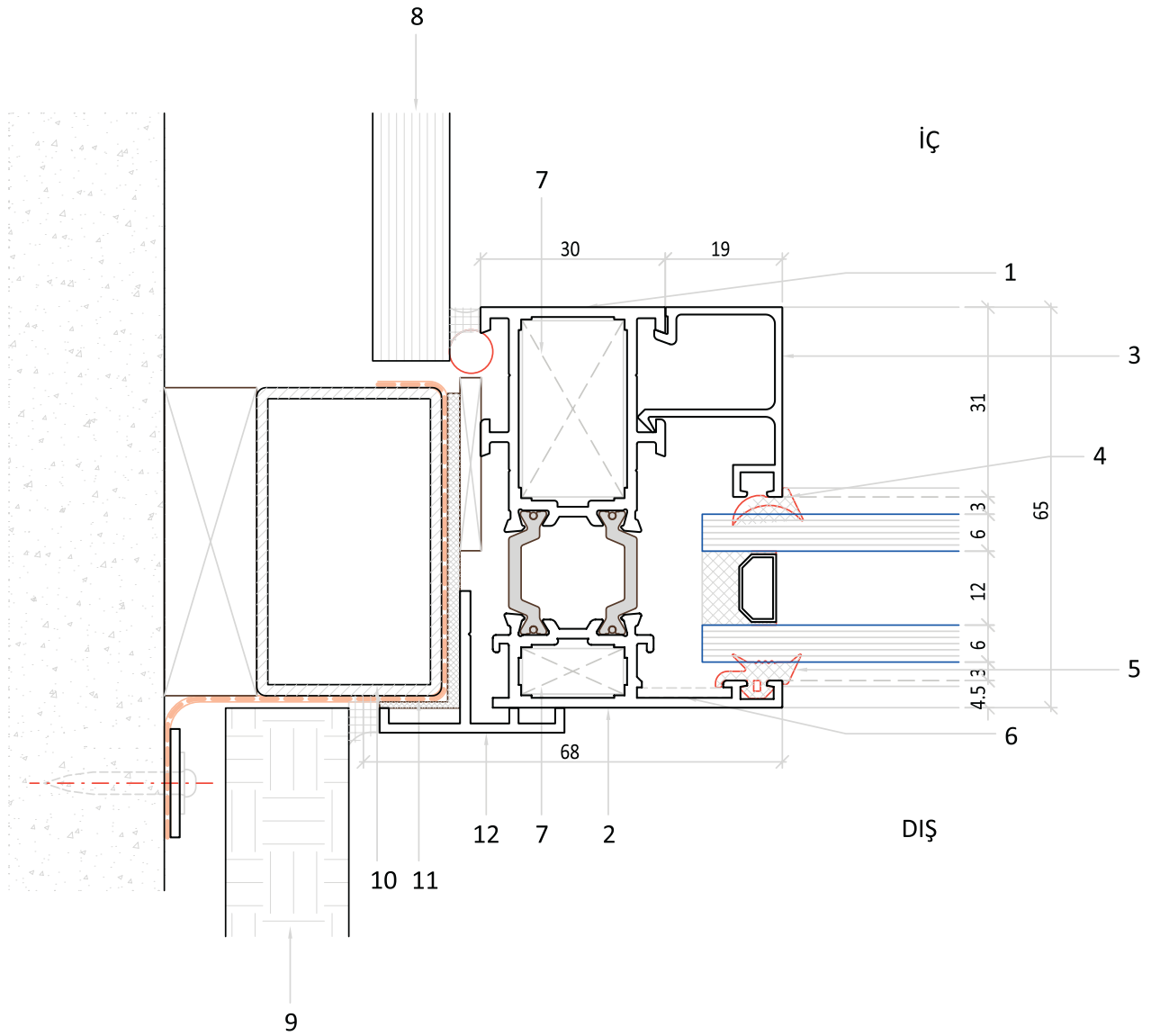

- 1 5800 KASA PROFİLİ (İÇ)
- 2 5802 KASA PROFİLİ (DIŞ)
- 3 5717 CAM ÇITASI
- 4 4401 EPDM FİTİL (İÇ CAM)
- 5 4400 EPDM FİTİL (DIŞ CAM)
- 6 KÖŞE ÇAVUŞU
- 7 5736 KÖŞE TAKOZU
- 8 İÇ KAPLAMA

- 9 DIŞ KAPLAMA
- 10 ÇELİK KÖRKASA
- 11 SU YALITIM MEMBRANI
- 12 5745 İÇ PERVAZ

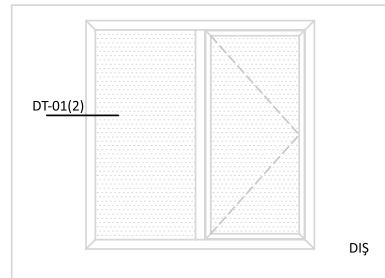



DT-01(2)

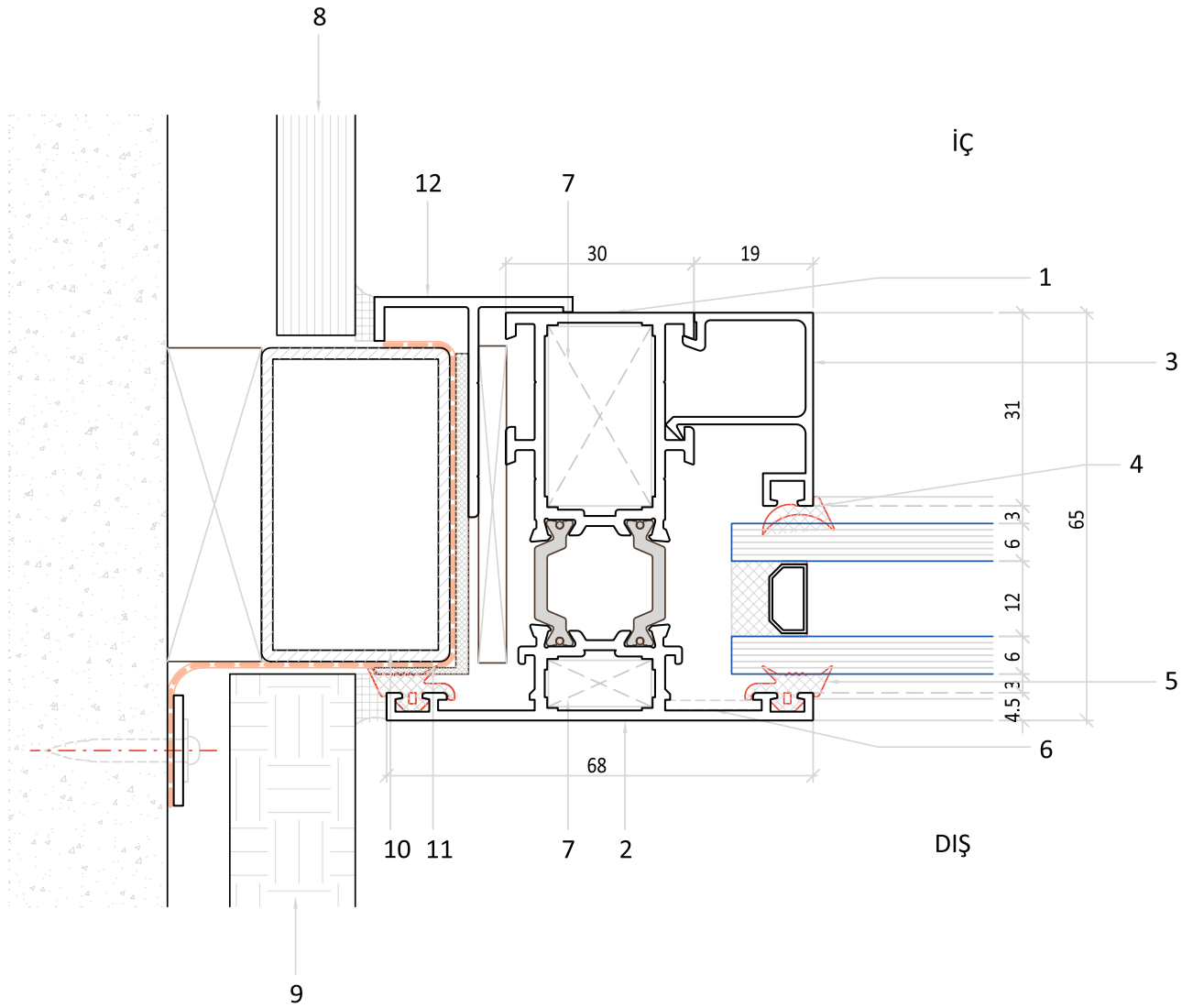

- 1 5800 KASA PROFİLİ (İÇ)
- 2 5801 KASA PROFİLİ (DIŞ)
- 3 5717 CAM ÇİTASI
- 4 4401 EPDM FİTİL (İÇ CAM)
- 5 4400 EPDM FİTİL (DIŞ CAM)
- 6 KÖŞE ÇAVUŞU
- 7 5736 KÖŞE TAKOZU
- 8 İÇ KAPLAMA

- 9 DIŞ KAPLAMA
- 10 ÇELİK KÖRKASA
- 11 SU YALITIM MEMBRANI
- 12 5745 İÇ PERVAZ

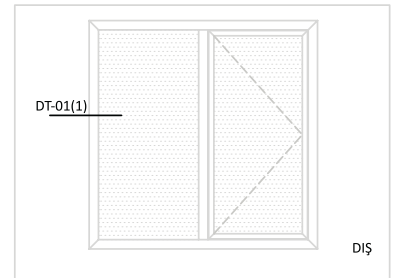

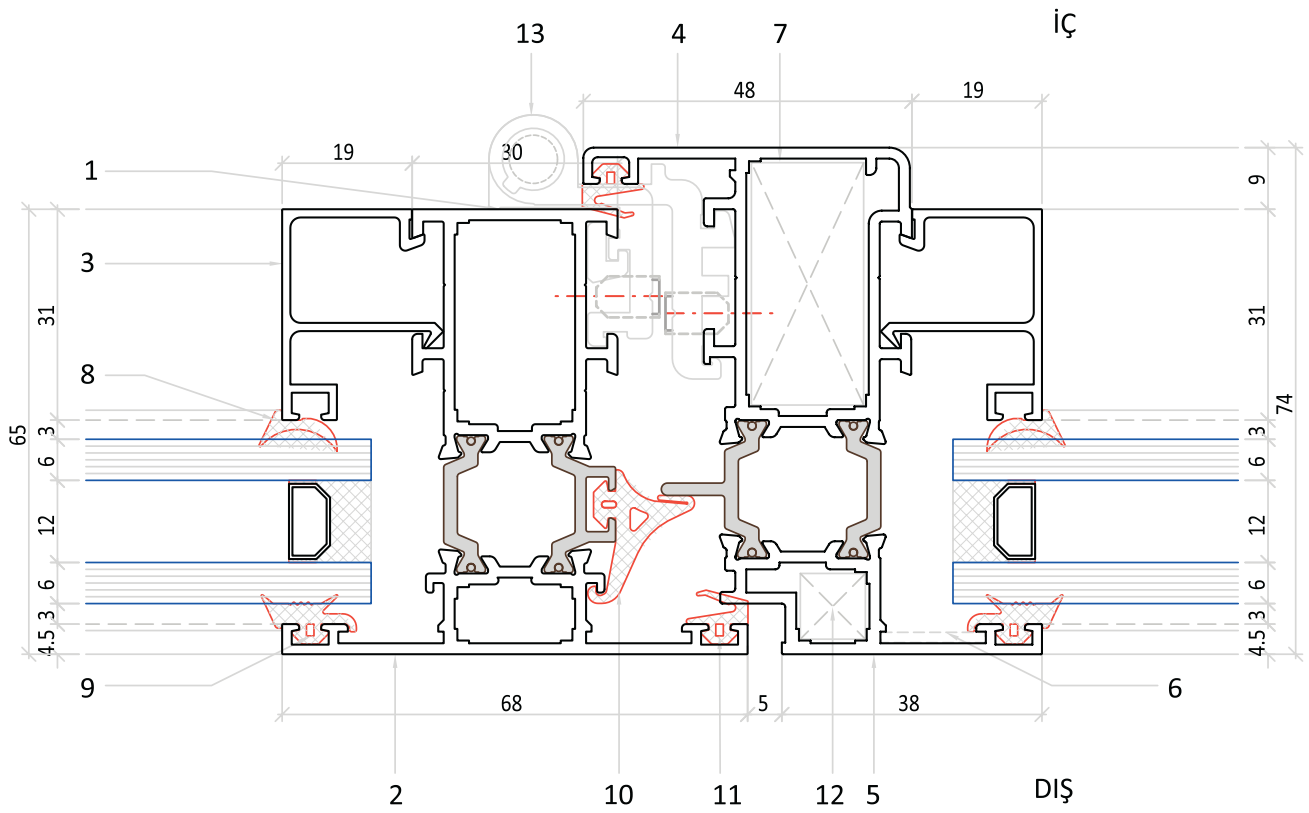

- 1 5800 ORTA KAYIT PROFİLİ (İÇ)
- 2 5801 ORTA KAYIT PROFİLİ (DIŞ)
- 3 5717 CAM ÇİTASI
- 4 5804 KANAT PROFİLİ (İÇ)
- 5 5805 KANAT PROFİLİ (DIŞ)
- 6 KÖŞE ÇAVUŞU
- 7 5736 KÖŞE TAKOZU
- 8 4401 EPDM FİTİL (İÇ CAM)

- 9 4400 EPDM FİTİL (DIŞ CAM)
- 10 4405 KASA-KANAT BİNİ FİTİLİ
- 11 4403 EPDM FİTİL
- 12 5741 KÖŞE TAKOZU
- 13 MENTEŞE

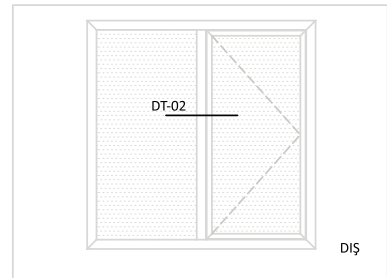

DT-03

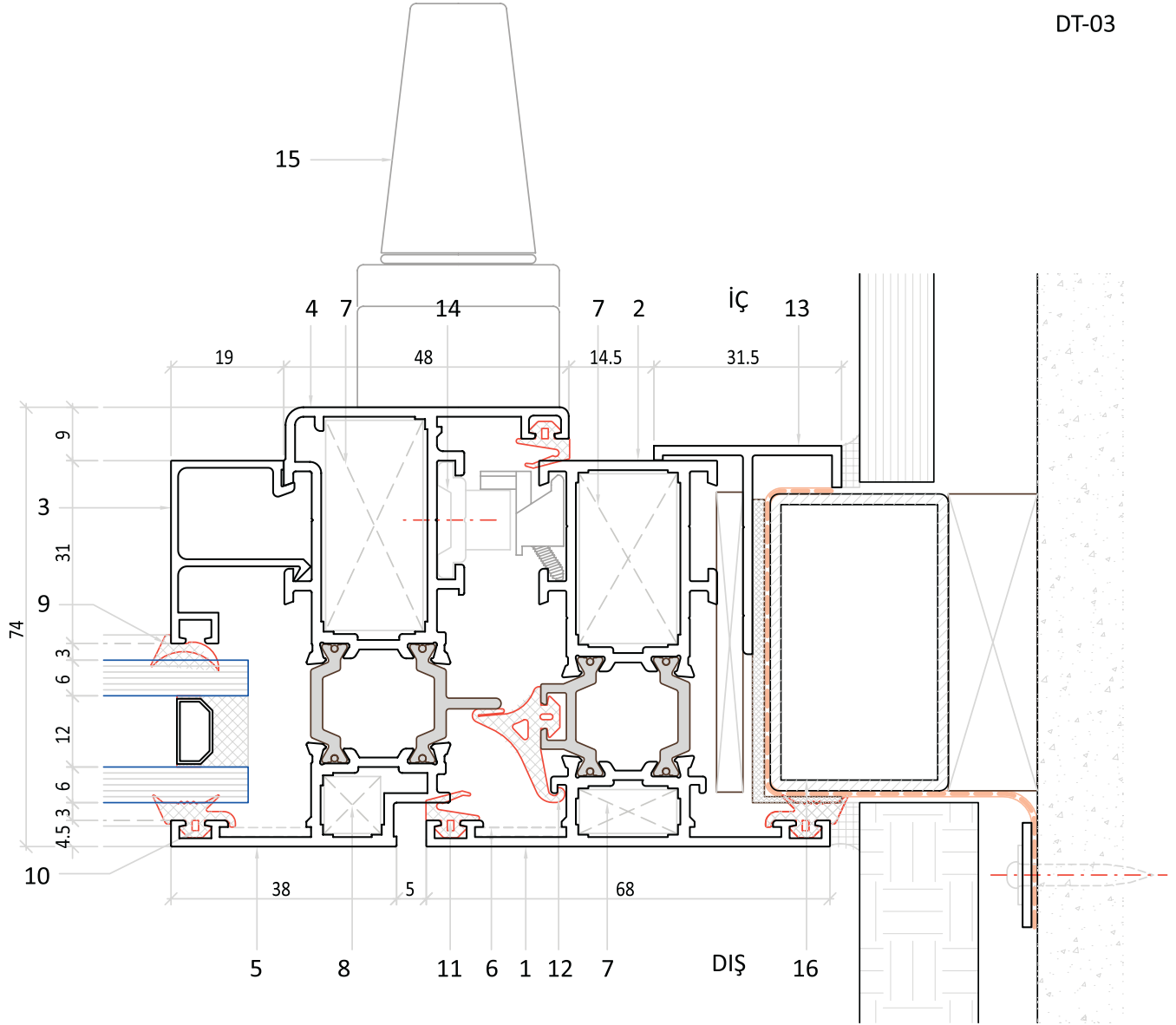

- 1 5800 ORTA KAYIT PROFİLİ (İÇ)
- 2 5801 ORTA KAYIT PROFİLİ (DIŞ)
- 3 5717 CAM ÇİTASI
- 4 5804 KANAT PROFİLİ (İÇ)
- 5 5805 KANAT PROFİLİ (DIŞ)
- 6 KÖŞE ÇAVUŞU
- 7 5736 KÖŞE TAKOZU
- 8 5741 KÖŞE TAKOZU

- 9 4401 EPDM FİTİL (İÇ CAM)
- 10 4400 EPDM FİTİL (DIŞ CAM)
- 11 4403 EPDM FİTİL
- 12 4405 KASA-KANAT BİNİ FİTİLİ
- 13 5745 İÇ PERVAZ
- 14 2416 KIZAK PROFİLİ
- 15 KOL
- 16 ÇELİK KÖRKASA

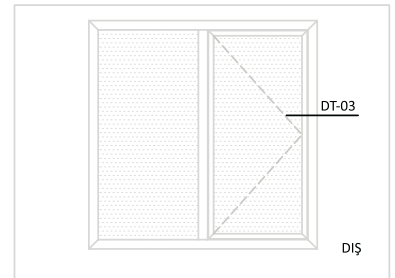

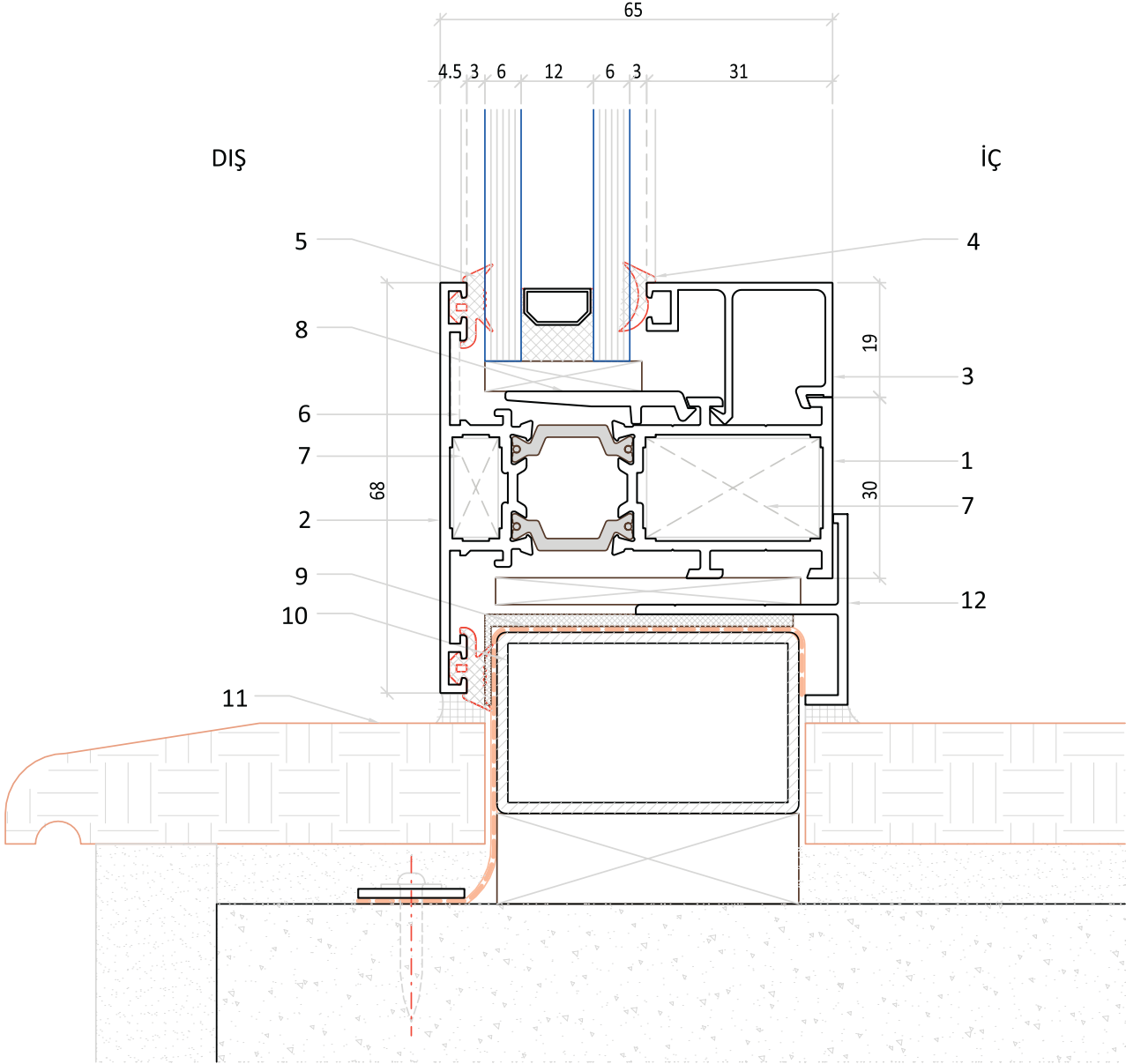

- 1 5800 KASA PROFİLİ (İÇ)
- 2 5801 KASA PROFİLİ (DIŞ)
- 3 5717 CAM ÇİTASI
- 4 4401 EPDM FİTİL (İÇ CAM)
- 5 4400 EPDM FİTİL (DIŞ CAM)
- 6 KÖŞE ÇAVUŞU
- 7 5736 KÖŞE TAKOZU
- 8 5719 CAM TAKOZU

- 9 SU YALITIM MEMBRANI
- 10 ÇELİK KÖRKASA
- 11 DENİZLİK
- 12 5745 İÇ PERVAZ

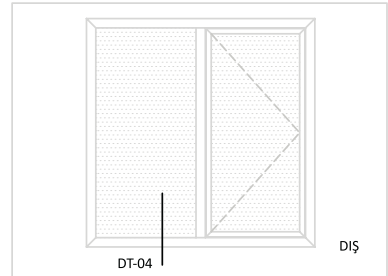

SBW 65 (1,6 mm) PENCERE - İÇE AÇILIR SİSTEM / KANAT ALT BİTİŞ DETAYI

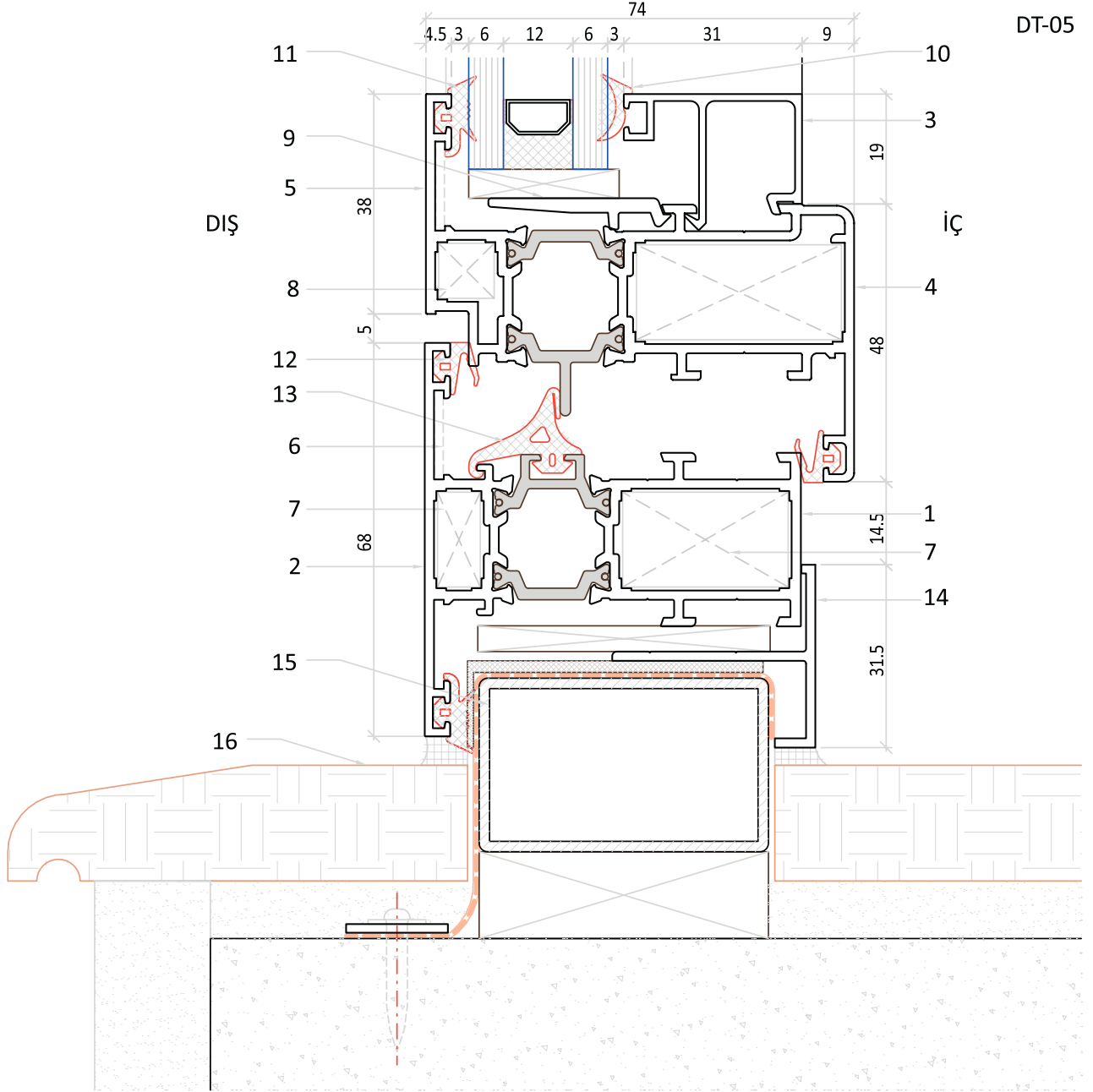

- 1 5800 ORTA KAYIT PROFİLİ (İÇ)
- 2 5801 ORTA KAYIT PROFİLİ (DIŞ)
- 3 5717 CAM ÇITASI
- 4 5804 KANAT PROFİLİ (İÇ)
- 5 5805 KANAT PROFİLİ (DIŞ)
- 6 KÖŞE ÇAVUŞU
- 7 5736 KÖŞE TAKOZU
- 8 5741 KÖŞE TAKOZU

- 9 5719 CAM TAKOZU
- 10 4401 EPDM FİTİL (İÇ CAM)
- 11 4400 EPDM FİTİL (DIŞ CAM)
- 12 4403 EPDM FİTİL
- 13 4405 KASA-KANAT BİNI FİTİLİ
- 14 5745 İÇ PERVAZ
- 15 ÇELİK KÖRKASA
- 16 DENİZLİK

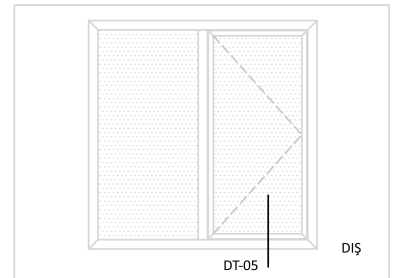

DT-06

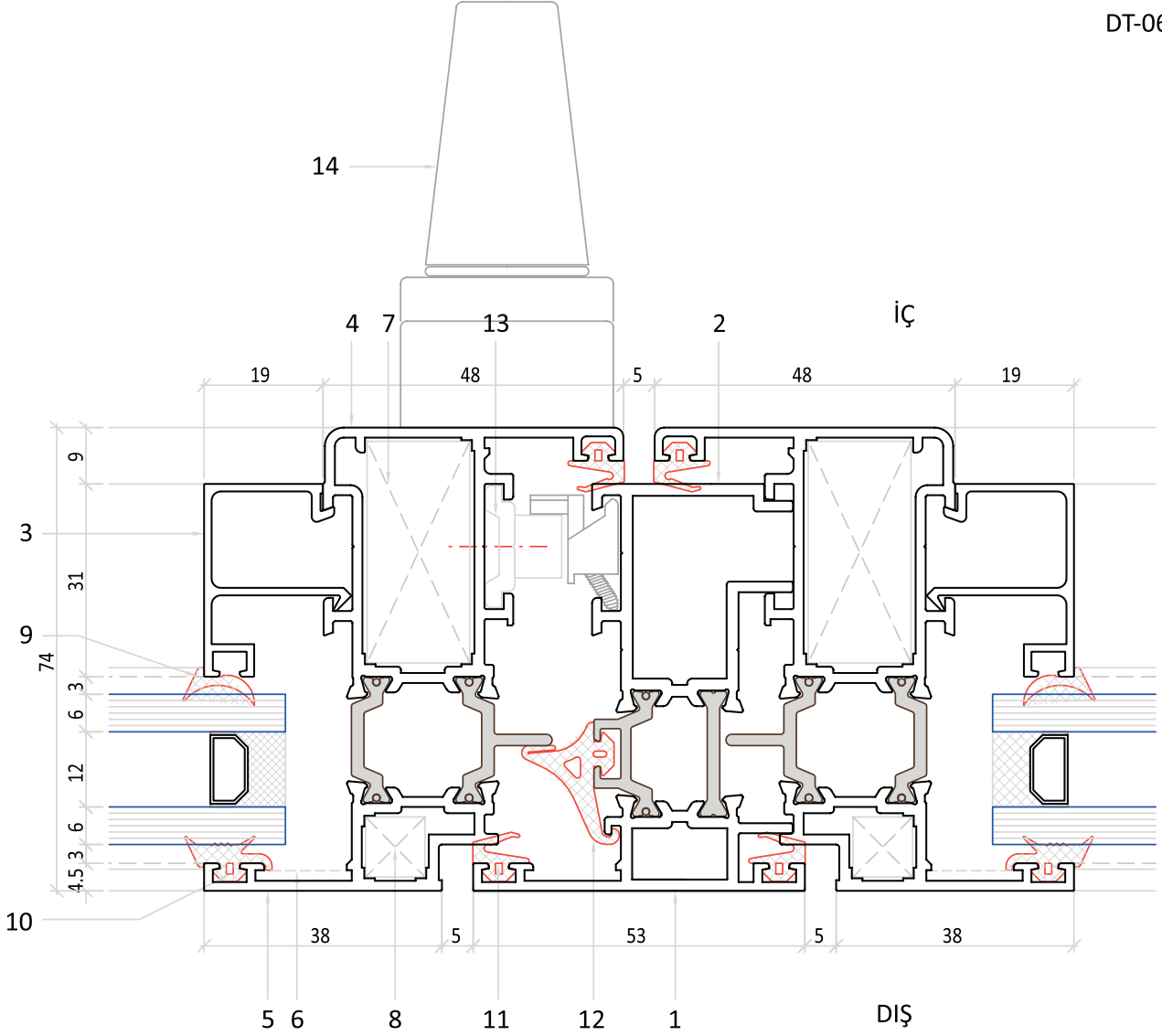

- 1 5707 ÇİFT KANAT ADAPTÖRÜ (DIŞ)
- 2 5706 ÇİFT KANAT ADAPTÖRÜ (İÇ)
- 3 5717 CAM ÇİTASI
- 4 5804 KANAT PROFİLİ (İÇ)
- 5 5805 KANAT PROFİLİ (DIŞ)
- 6 KÖŞE ÇAVUŞU
- 7 5736 KÖŞE TAKOZU
- 8 5741 KÖŞE TAKOZU

- 9 4401 EPDM FİTİL (İÇ CAM)
- 10 4400 EPDM FİTİL (DIŞ CAM)
- 11 4403 EPDM FİTİL
- 12 4405 KASA-KANAT BİNE FİTİLİ
- 13 2416 KIZAK PROFİLİ
- 14 KOL

