

STARKBAU
ALUMINYUM PROFİL SİSTEMLERİ
www.starkbau.com

STARKBAU
ALUMINYUM PROFİL SİSTEMLERİ

SBF 50

GIYDIRME CEPHE SİSTEMİ

STARKBAU bir ALPSAN tescilli markasıdır.

Bağış Mah. Koşuyolu Cad. 180/4 Sk. No: 3 41400 Gebze - Kocaeli Tel: 0 262 642 84 42 Faks: 0 262 642 84 41



STARKBAU
ALÜMİNYUM PROFİL SİSTEMLERİ

NO	PROFİL ŞEKLİ	KALIP NO	PROFİL ADI	AĞIRLIK (kg/mt)	SAYFA NO
1		5000	YATAY PROFİL (1.5 mm) 50 mm	1,324	29
2		5001	YATAY PROFİL (1.5 mm) 75 mm	1,668	29
3		5002	YATAY PROFİL (1.5 mm) 100 mm	1,939	29
4		5003	YATAY PROFİL (1.5 mm) 125 mm	2,210	29
5		5004	YATAY PROFİL (2 mm) 150 mm	2,481	29
6		5005	YATAY PROFİL (2 mm) 175 mm	2,752	29
7		5006	YATAY PROFİL (2 mm) 200 mm	3,044	29
8		5007	YATAY PROFİL (2 mm) 50 mm	1,454	28
9		5008	YATAY PROFİL (2 mm) 75 mm	1,725	28
10		5009	YATAY PROFİL (2 mm) 100 mm	1,996	28
11		5010	YATAY PROFİL (2 mm) 125 mm	2,266	28
12		5011	YATAY PROFİL (2 .5 mm) 150 mm	3,166	28
13		5012	YATAY PROFİL (2 .5 mm) 175 mm	3,505	28
14		5013	YATAY PROFİL (2 .5 mm) 200 mm	3,966	28
15		5014	DÜŞEY PROFİL (2 mm) 45 mm	1,621	27
16		5015	DÜŞEY PROFİL (2 mm) 70 mm	1,892	27
17		5016	DÜŞEY PROFİL (2 mm) 95 mm	2,163	27
18		5017	DÜŞEY PROFİL (2 mm) 120 mm	2,434	27
19		5018	DÜŞEY PROFİL (2.5 mm) 145 mm	3,543	27
20		5019	DÜŞEY PROFİL (2.5 mm) 170 mm	3,881	27
21		5020	DÜŞEY PROFİL (2.5 mm) 195 mm	4,464	27
22		5050	KAPAK PROFİLİ 100 mm	1,143	30
23		5051	KAPAK PROFİLİ 17 mm	0,324	30
24		5052	KAPAK PROFİLİ 15 mm	0,309	30
25		5053	KAPAK PROFİLİ 13 mm	0,294	30
26		5054	ALT KAPAK PROFİLİ	0,326	30
27		5055	CAM TAKOZU PROFİLİ 31 mm (cam kalınlığı 24 mm'e kadar)	0,240	30
28		5056	CAM TAKOZU PROFİLİ 36 mm (cam kalınlığı 32 mm'e kadar)	0,267	30
29		5100	DIŞ KÖŞE KAPAK	0,752	31

NO	PROFİL ŞEKLİ	KALIP NO	PROFİL ADI	AĞIRLIK (kg/mt)	SAYFA NO
30		5101	DIŞ KÖŞE ALT KAPAK	0,825	31
31		5102	İÇ KÖŞE KAPAK	0,250	31
32		5103	İÇ KÖŞE ALT KAPAK	0,317	31
33		5104	İÇ KÖŞE ADAPTÖR	0,278	31
34		5105	İÇ KÖŞE ADAPTÖR	0,132	31
35		5106	CAM YUVASI KÜÇÜLTME PROFİLİ (12 mm)	0,138	31
36		5107	CAM YUVASI KÜÇÜLTME PROFİLİ (18 mm)	0,180	31
37		5115	PANO PROFİLİ	1,023	32
38		5116	İZOLASYONLU PANO PROFİLİ	1,289	32
39		5117	CEPHE İÇİ KANAT PROFİLİ	1,200	32
40		5118	CEPHE İÇİ KANAT KASA PROFİLİ	0,797	32
41		5119	KOMPOZE PANO PROFİLİ	0,770	32
42		5120	CAM YAPIŞTIRMA PROFİLİ	0,279	32
43		5121	CAM YAPIŞTIRMA PROFİLİ	0,130	32
44		5122	CAM TAKOZU	0,192	32
45		5123	CAM TAKOZU	0,172	32
46		5124	MONTAJ PROFİLİ	0,268	32
47		5131	CEPHE İÇİ KANAT CAM YAPIŞTIRMA PROFİLİ	0,302	32
48		5125	DİLATASYON PROFİLİ	3,601	33
49		5126	BAĞLANTI PROFİLİ	1,672	33
50		5127	BAĞLANTI PROFİLİ	0,467	33
51		5128	PANO PROFİLİ KÖŞE TAKOZU	3,983	34
52		5129	PANO PROFİLİ KÖŞE TAKOZU	2,936	34
53		5130	PANO PROFİLİ KÖŞE TAKOZU	3,566	34
54		CP-1	BOYUN PLASTİĞİ 12,5 mm		36
55		CP-2	BOYUN PLASTİĞİ 15 mm		36
56		CP-3	BOYUN PLASTİĞİ 18 mm		36
57		CP-4	BOYUN PLASTİĞİ 25 mm		36
58		CP-5	BOYUN PLASTİĞİ 14,8 mm		36

SBF 50 DETAY ÇİZİMLERİ

STARKBAU
ALÜMİNYUM PROFİL SİSTEMLERİ

SBF 50 / PARAPET CAMI DETAYI (DÜŞEY)

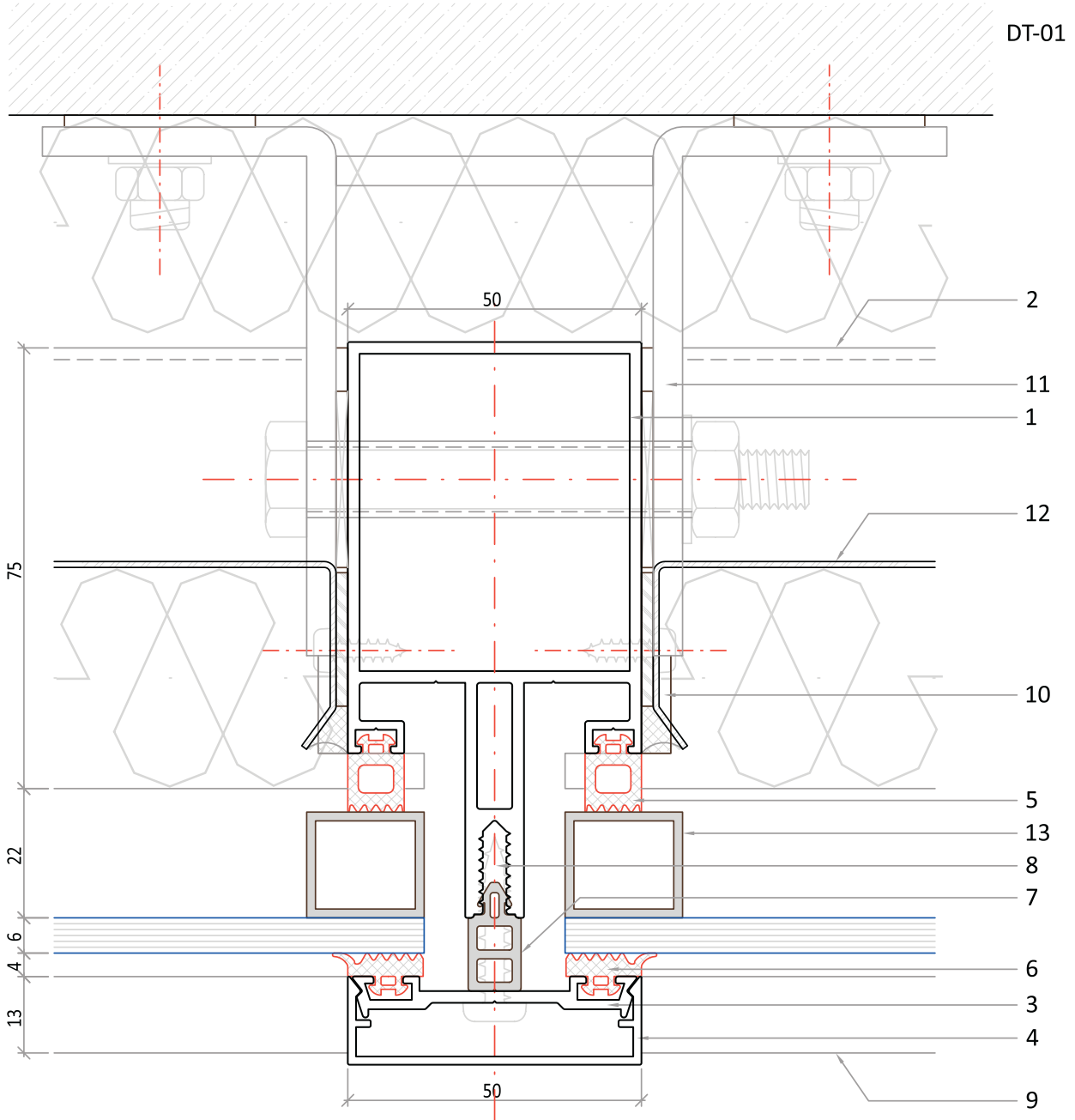

- 1 5015 DÜŞEY PROFİL
- 2 5008 YATAY PROFİL
- 3 5054 ALT KAPAK PROFİLİ
- 4 5052 DÜŞEY KAPAK PROFİLİ
- 5 CF-20 İÇ CAM FİTİLİ
- 6 CF-24 DIŞ CAM FİTİLİ
- 7 CP-1 BOYUN PLASTİĞİ
- 8 5,5 SB VİDA
- 9 5053 YATAY KAPAK PROFİLİ

- 10 YATAY KAYIT CONTASI
- 11 TAŞIYICI ÇELİK ANKRAJ
- 12 1 mm GALVANİZ LEVHA
- 13 18 x 20 x 1.5 mm PVC KUTU

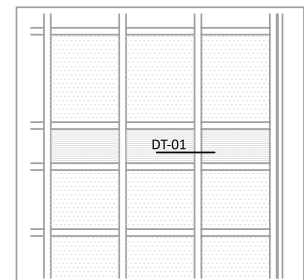

DT-02

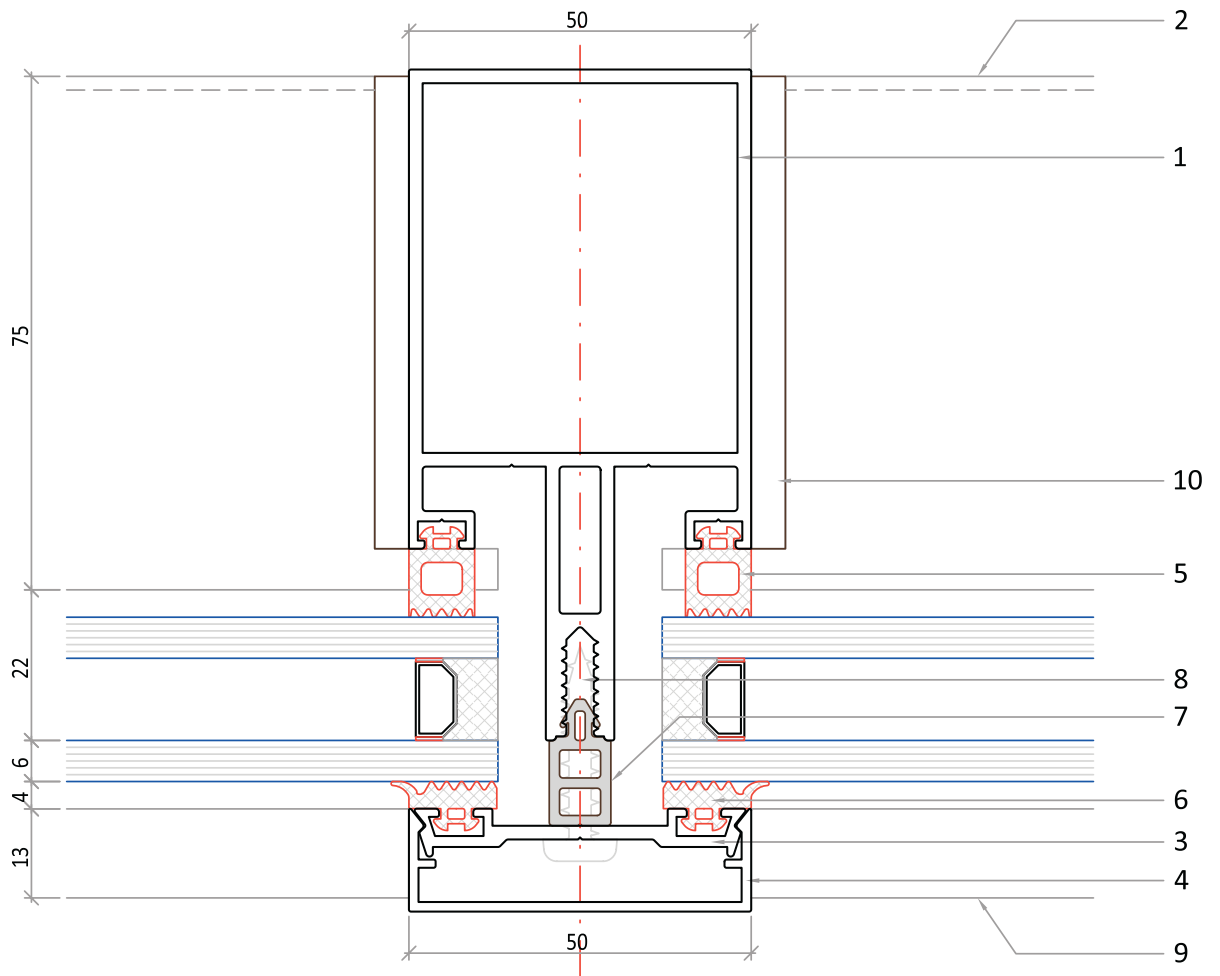

- 1 5015 DÜŞEY PROFİL
- 2 5008 YATAY PROFİL
- 3 5054 ALT KAPAK PROFİLİ
- 4 5052 DÜŞEY KAPAK PROFİLİ
- 5 CF-20 İÇ CAM FİTİLİ
- 6 CF-24 DIŞ CAM FİTİLİ
- 7 CP-1 BOYUN PLASTİĞİ
- 8 5.5 SB VİDA
- 9 5053 YATAY KAPAK PROFİLİ
- 10 YATAY KAYIT CONTASI

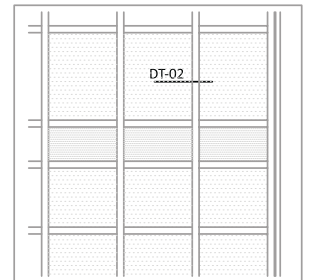
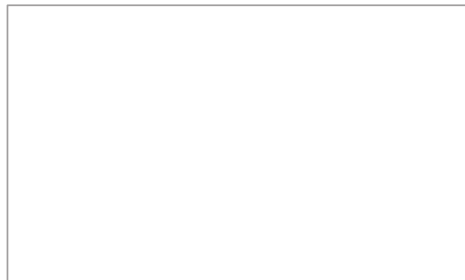

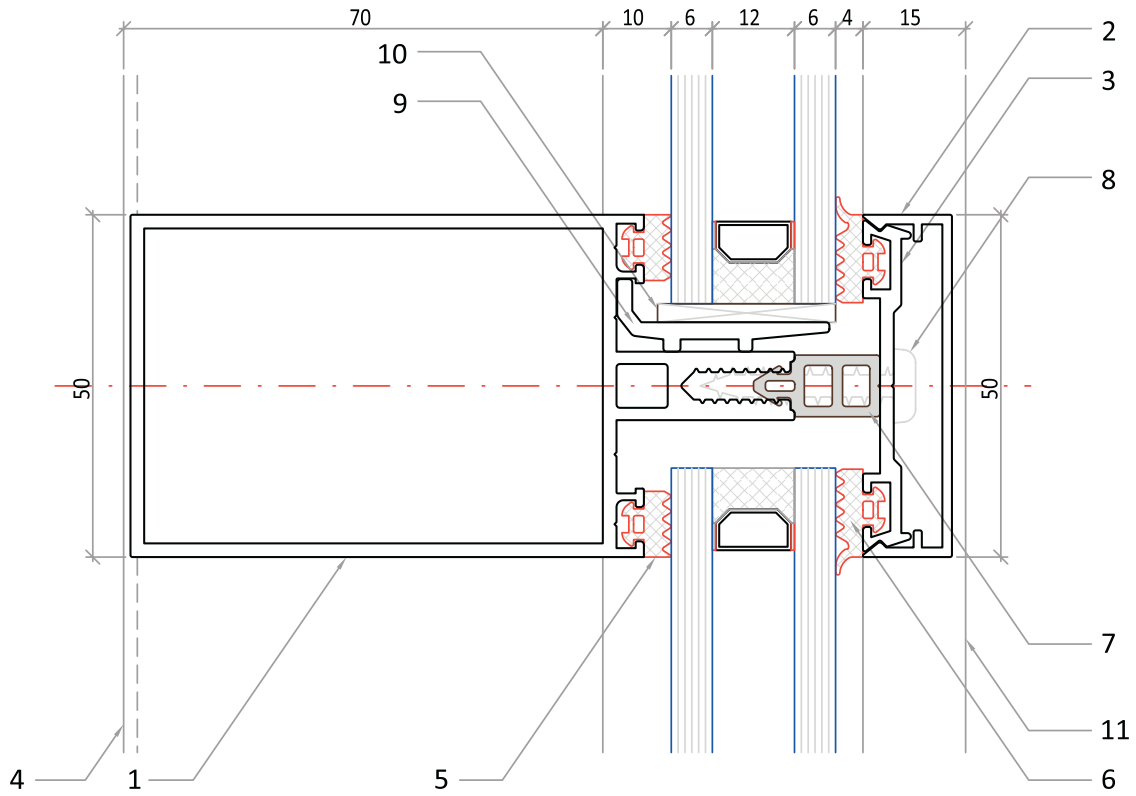

- 1 5008 YATAY PROFİL
- 2 5053 YATAY KAPAK PROFİLİ
- 3 5054 ALT KAPAK PROFİLİ
- 4 5015 DÜŞEY PROFİL
- 5 CF-23 İÇ CAM FİTİLİ
- 6 CF-24 DIŞ CAM FİTİLİ
- 7 CP-1 BOYUN PLASTİĞİ
- 8 5.5 SB VİDA
- 9 5055 CAM TAKOZU PROFİLİ

- 10 CAM TAKOZU
- 11 5052 DÜŞEY KAPAK PROFİLİ

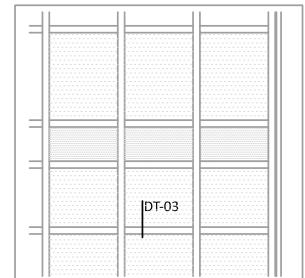

DT-04

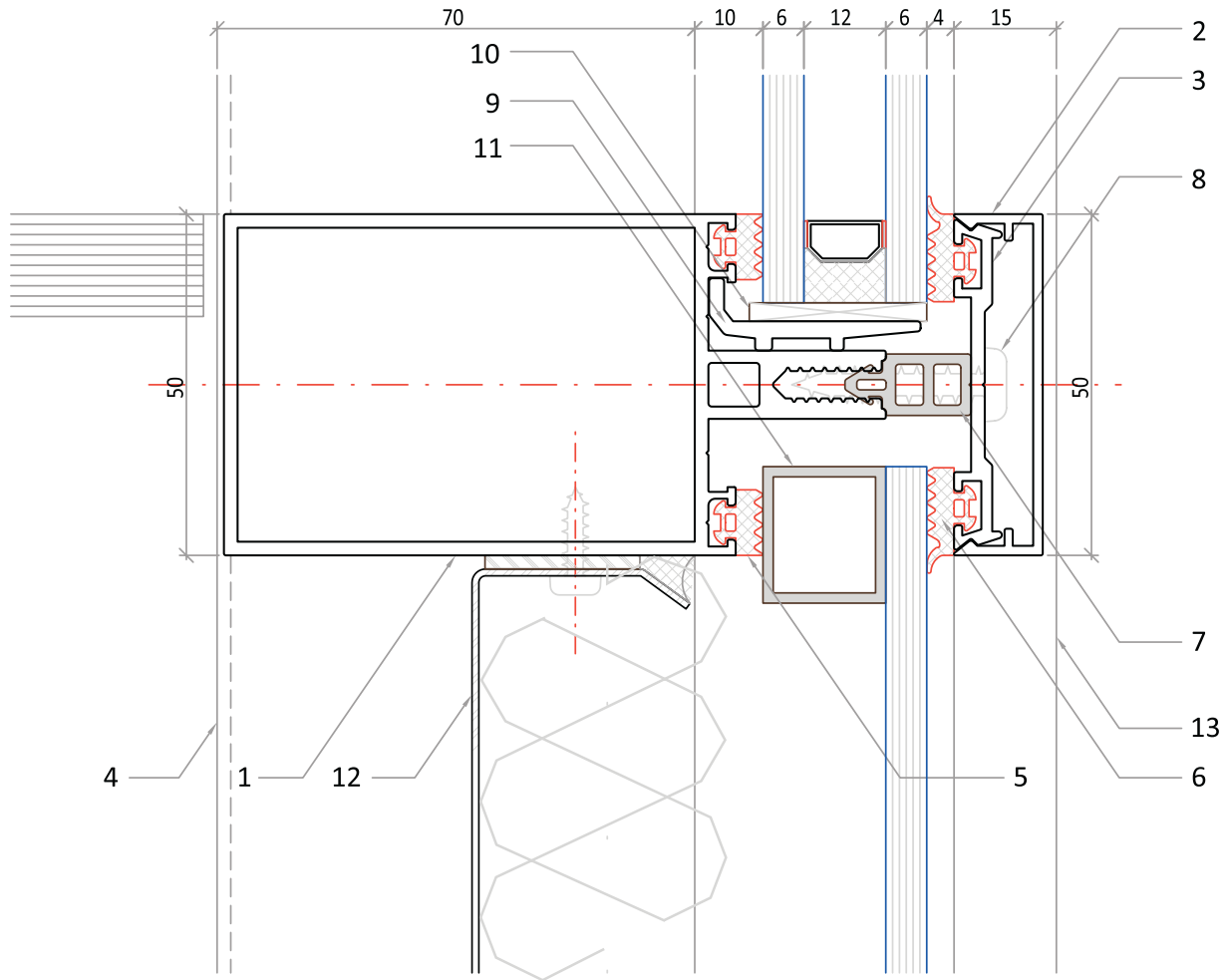

- 1 5008 YATAY PROFİL
- 2 5053 YATAY KAPAK PROFİLİ
- 3 5054 ALT KAPAK PROFİLİ
- 4 5015 DÜŞEY PROFİL
- 5 CF-23 İÇ CAM FİTİLİ
- 6 CF-24 DIŞ CAM FİTİLİ
- 7 CP-1 BOYUN PLASTİĞİ
- 8 5.5 SB VİDA
- 9 5055 CAM TAKOZU PROFİLİ

- 10 CAM TAKOZU
- 11 18 x 20 x 1.5 mm PVC KUTU
- 12 1 mm GALVANİZ LEVHA
- 13 5052 DÜŞEY KAPAK PROFİLİ

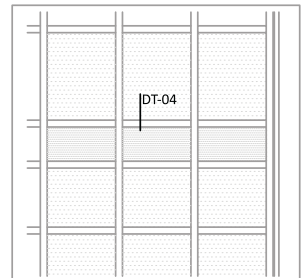

SBF 50 / DUVAR BİTİŞ DETAYI (DÜŞEY)

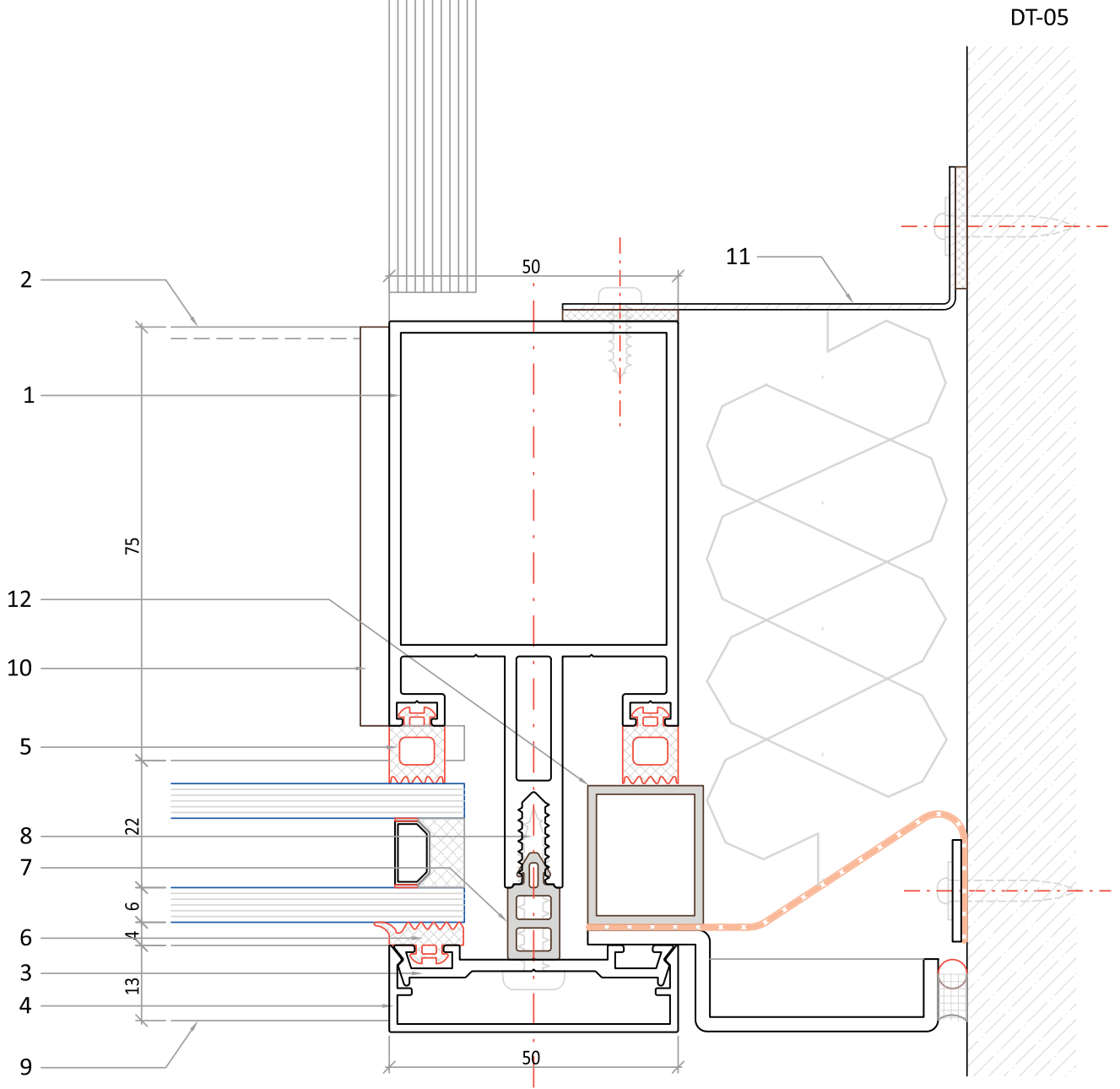

- 1 5015 DÜŞEY PROFİL
- 2 5008 YATAY PROFİL
- 3 5054 ALT KAPAK PROFİLİ
- 4 5052 DÜŞEY KAPAK PROFİLİ
- 5 CF-20 İÇ CAM FİTİLİ
- 6 CF-24 DIŞ CAM FİTİLİ
- 7 CP-1 BOYUN PLASTİĞİ
- 8 5.5 SB VİDA
- 9 5053 YATAY KAPAK PROFİLİ

- 10 YATAY KAYIT CONTASI
- 11 1 mm GALVANİZ LEVHA
- 12 18 x 20 x 1.5 mm PVC KUTU

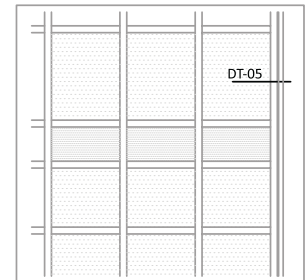

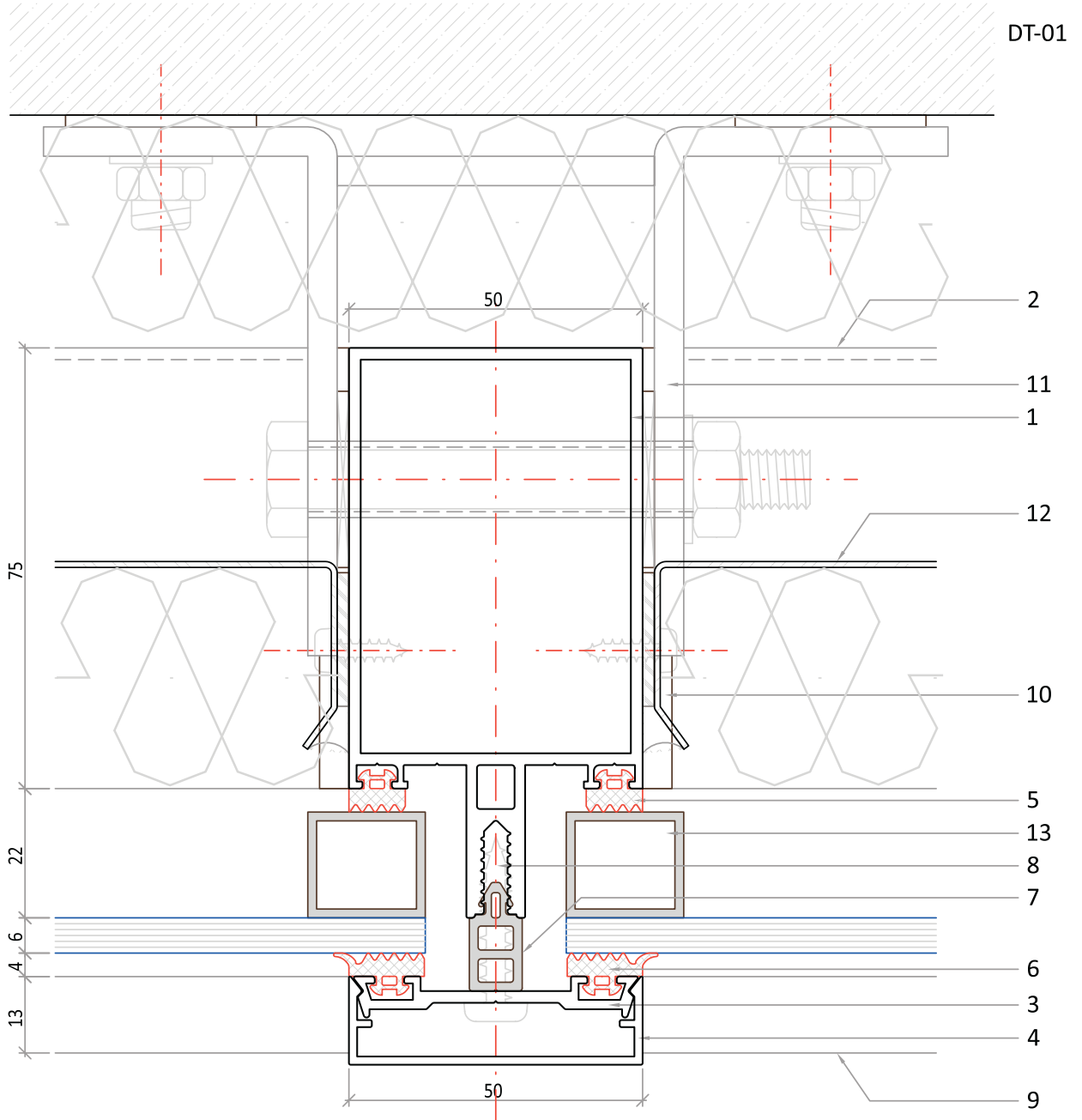

- 1 5008 YATAY PROFİL
- 2 5008 YATAY PROFİL
- 3 5054 ALT KAPAK PROFİLİ
- 4 5052 DÜŞEY KAPAK PROFİLİ
- 5 CF-23 İÇ CAM FİTİLİ
- 6 CF-24 DIŞ CAM FİTİLİ
- 7 CP-1 BOYUN PLASTİĞİ
- 8 5.5 SB VİDA
- 9 5053 YATAY KAPAK PROFİLİ

- 10 YATAY KAYIT CONTASI
- 11 TAŞIYICI ÇELİK ANKRAJ
- 12 1 mm GALVANİZ LEVHA
- 13 18 x 20 x 1.5 mm PVC KUTU

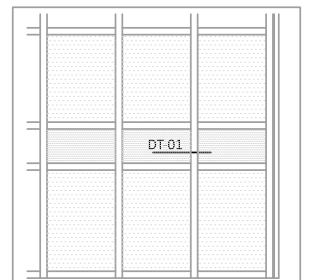

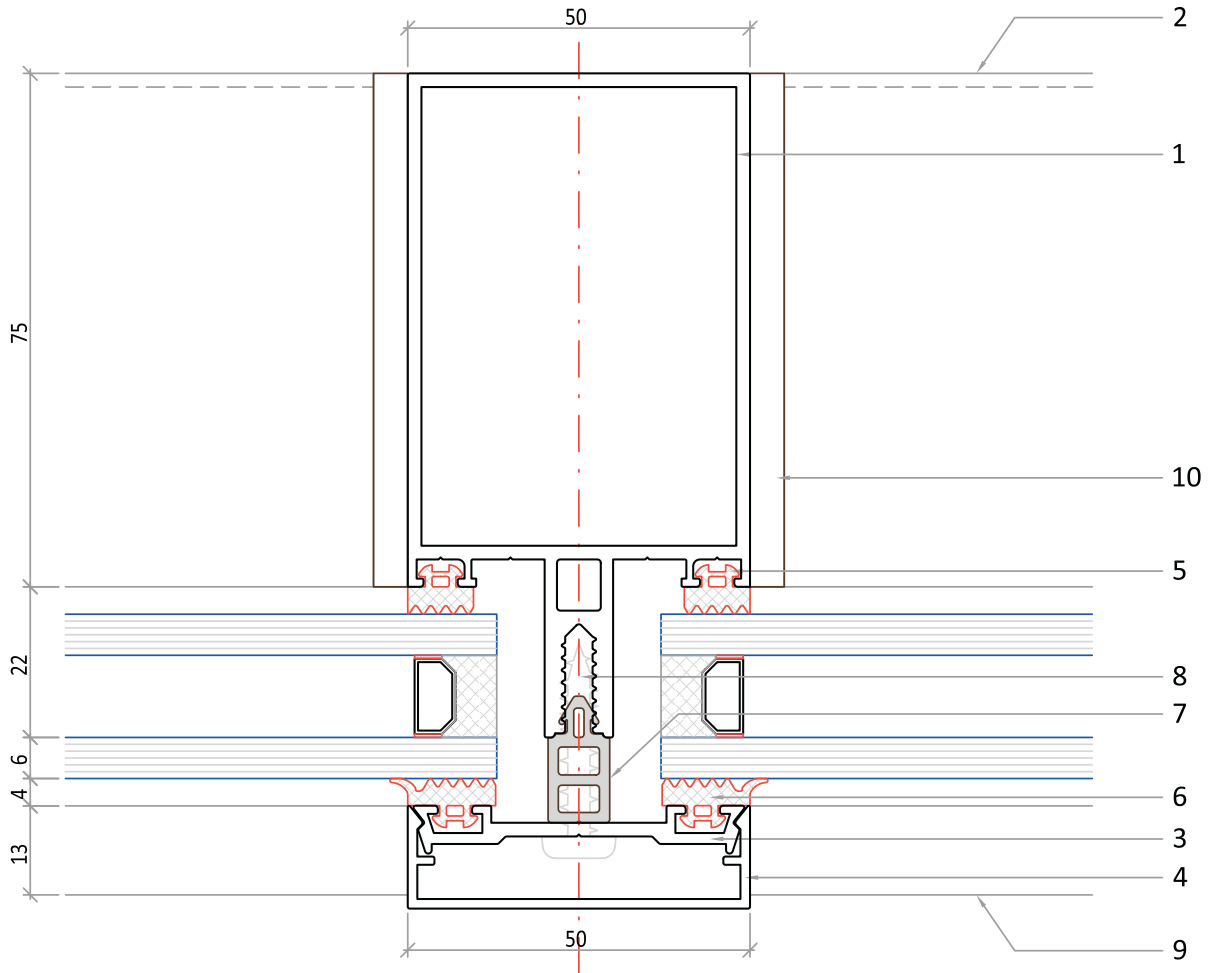

- 1 5008 YATAY PROFİL
- 2 5008 YATAY PROFİL
- 3 5054 ALT KAPAK PROFİLİ
- 4 5052 DÜŞEY KAPAK PROFİLİ
- 5 CF-23 İÇ CAM FİTİLİ
- 6 CF-24 DIŞ CAM FİTİLİ
- 7 CP-1 BOYUN PLASTİĞİ
- 8 5.5 SB VİDA
- 9 5053 YATAY KAPAK PROFİLİ
- 10 YATAY KAYIT CONTASI

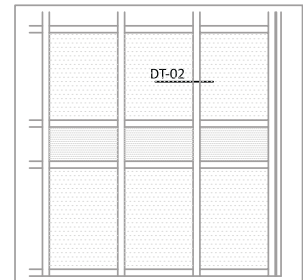
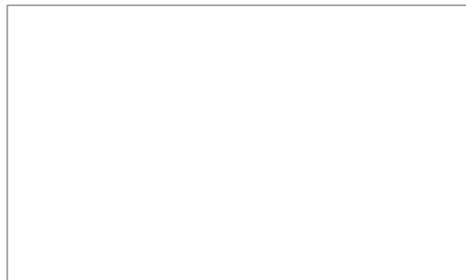

DT-03

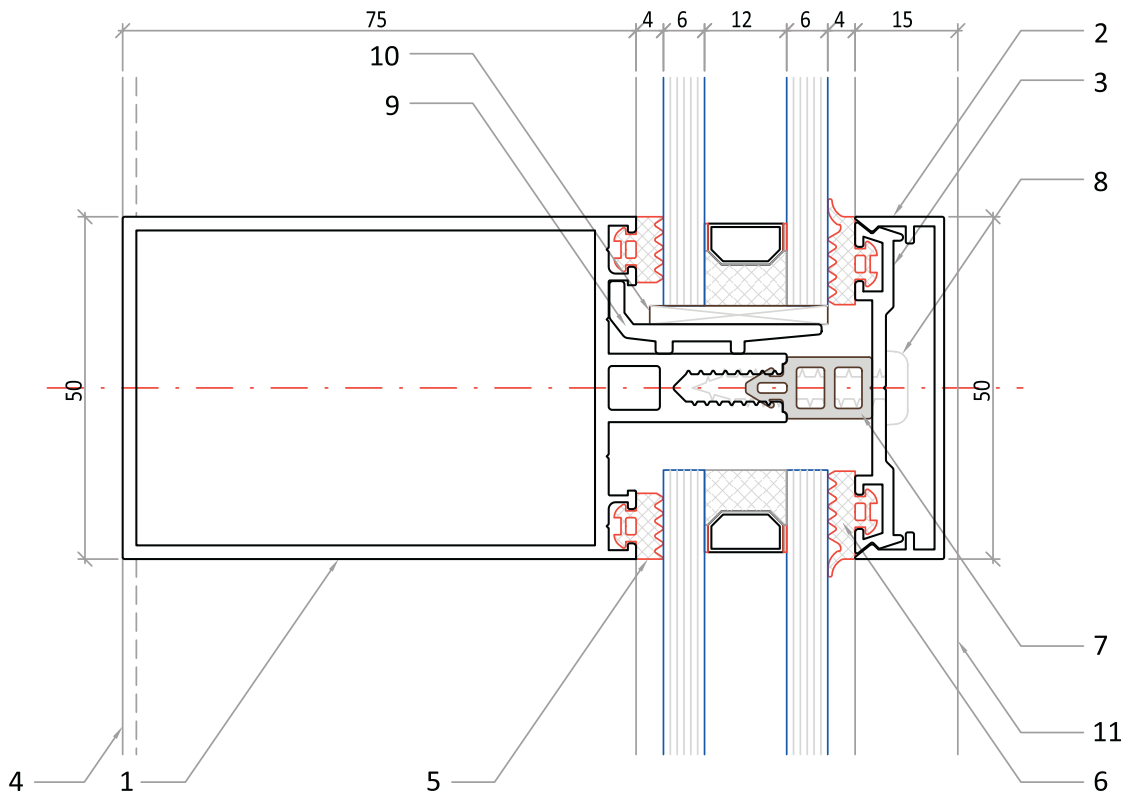

- 1 5008 YATAY PROFİL
- 2 5053 YATAY KAPAK PROFİLİ
- 3 5054 ALT KAPAK PROFİLİ
- 4 5008 YATAY PROFİL
- 5 CF-23 İÇ CAM FİTİLİ
- 6 CF-24 DIŞ CAM FİTİLİ
- 7 CP-1 BOYUN PLASTİĞİ
- 8 5.5 SB VİDA
- 9 5055 CAM TAKOZU PROFİLİ

- 10 CAM TAKOZU
- 11 5052 DÜŞEY KAPAK PROFİLİ

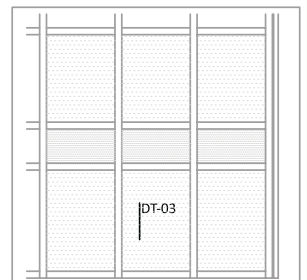

DT-04

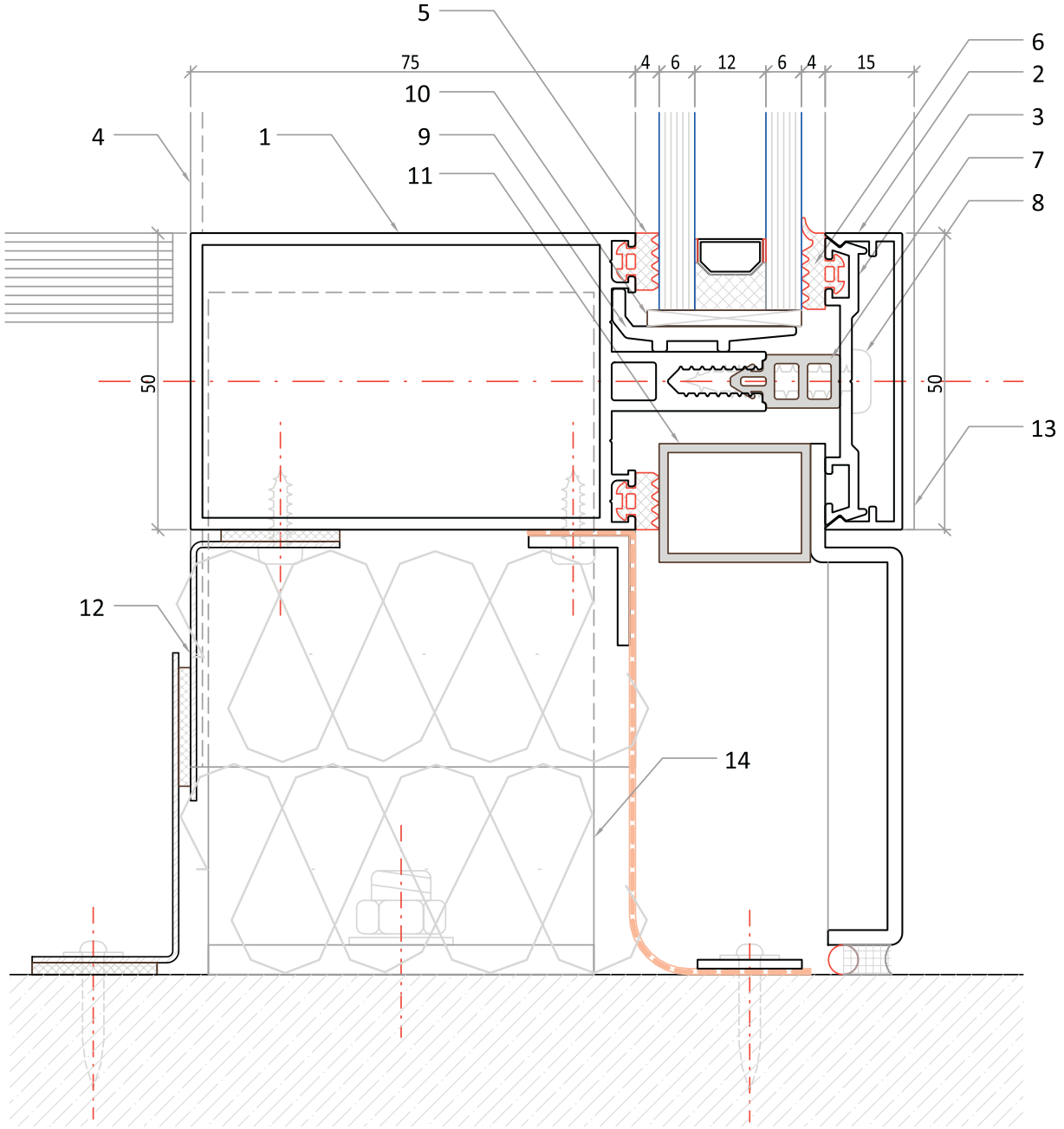

- 1 5008 YATAY PROFİL
- 2 5053 YATAY KAPAK PROFİLİ
- 3 5054 ALT KAPAK PROFİLİ
- 4 5008 YATAY PROFİL
- 5 CF-23 İÇ CAM FİTİLİ
- 6 CF-24 DIŞ CAM FİTİLİ
- 7 CP-1 BOYUN PLASTİĞİ
- 8 5,5 SB VİDA
- 9 5055 CAM TAKOZU PROFİLİ

- 10 CAM TAKOZU
- 11 20 x 25,5 x 1,5 mm PVC KUTU
- 12 1 mm GALVANİZ LEVHA
- 13 5052 DÜŞEY KAPAK PROFİLİ
- 14 TAŞIYICI ÇELİK ANKRAJ

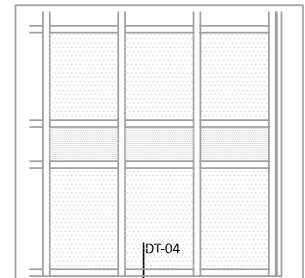

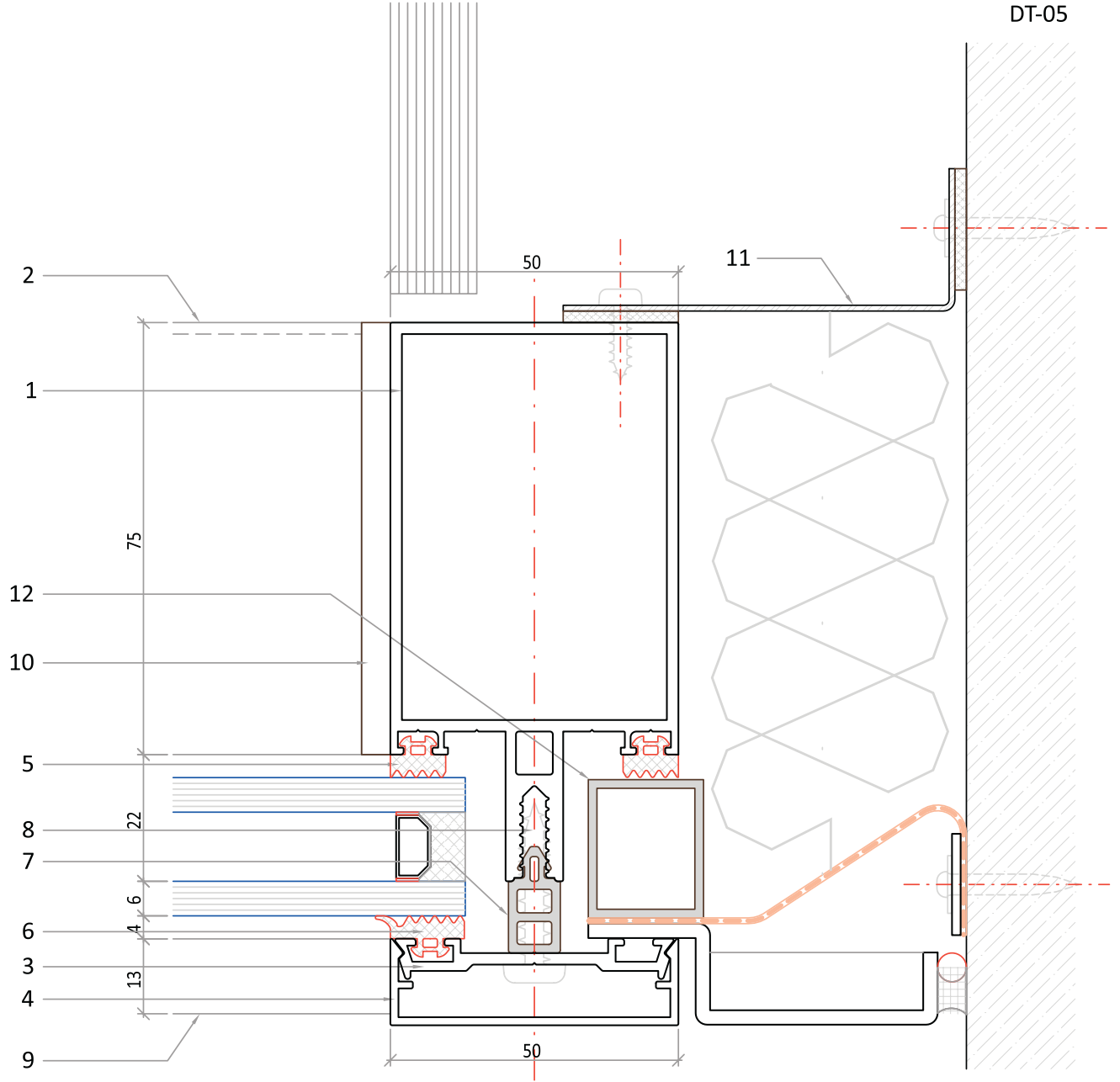

- 1 5008 YATAY PROFİL
- 2 5008 YATAY PROFİL
- 3 5054 ALT KAPAK PROFİLİ
- 4 5052 DÜŞEY KAPAK PROFİLİ
- 5 CF-23 İÇ CAM FİTİLİ
- 6 CF-24 DIŞ CAM FİTİLİ
- 7 CP-1 BOYUN PLASTİĞİ
- 8 5.5 SB VİDA
- 9 5053 YATAY KAPAK PROFİLİ

- 10 YATAY KAYIT CONTASI
- 11 1 mm GALVANİZ LEVHA
- 12 18 x 20 x 1.5 mm PVC KUTU

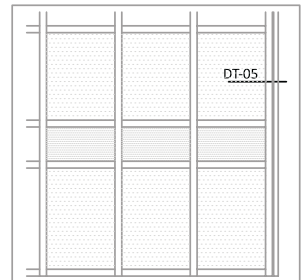

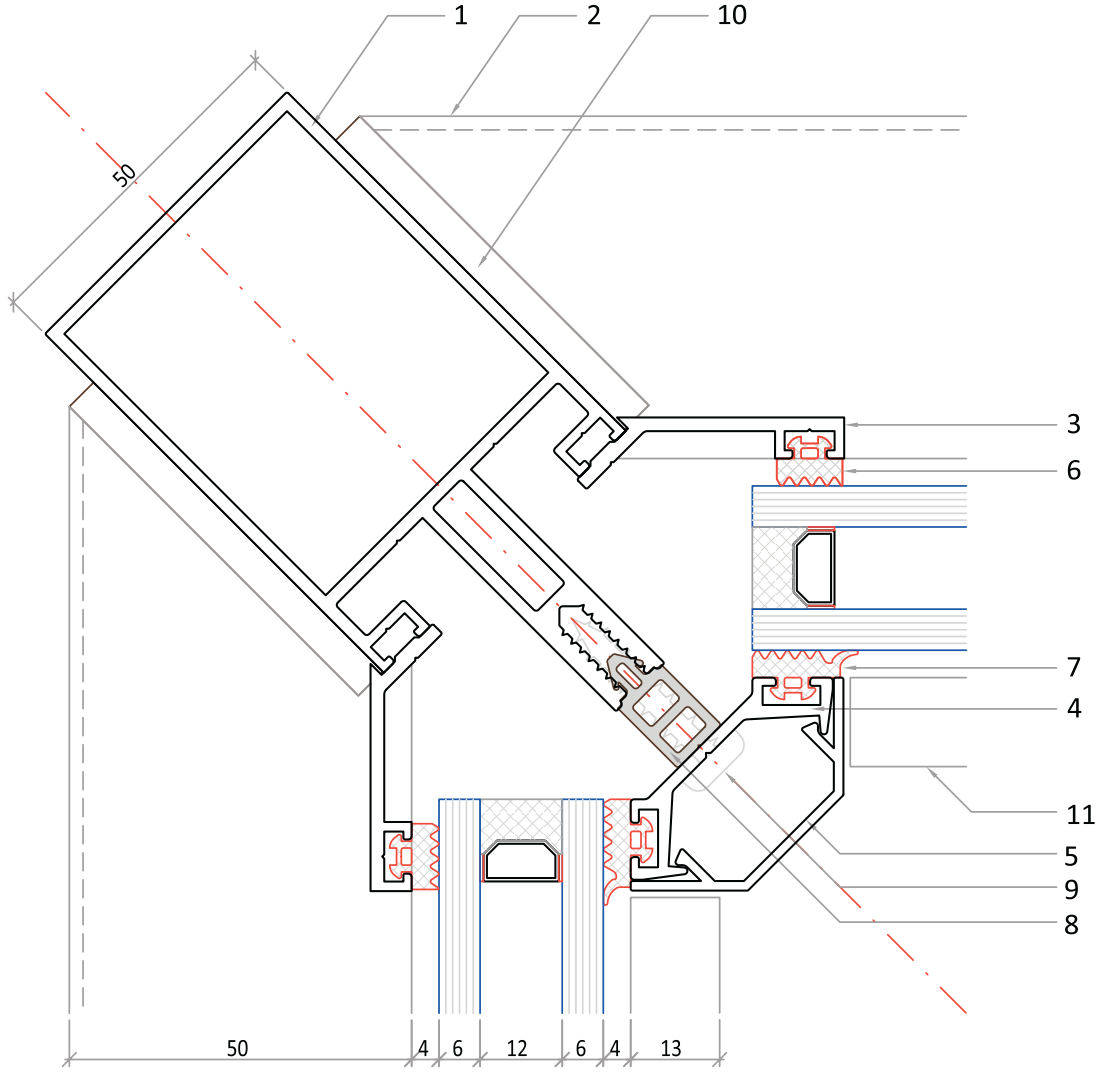

- 1 5015 DÜŞEY PROFİL
- 2 5007 YATAY PROFİL
- 3 5104 İÇ KÖŞE ADAPTÖR PROFİLİ
- 4 5103 İÇ KÖŞE ALT KAPAK PROFİLİ
- 5 5102 İÇ KÖŞE DÜŞEY KAPAK PROFİLİ
- 6 CF-23 İÇ CAM FİTİLİ
- 7 CF-24 DIŞ CAM FİTİLİ
- 8 CP-1 BOYUN PLASTİĞİ
- 9 5.5 SB VİDA

- 10 YATAY KAYIT CONTASI
- 11 5053 YATAY KAPAK PROFİLİ

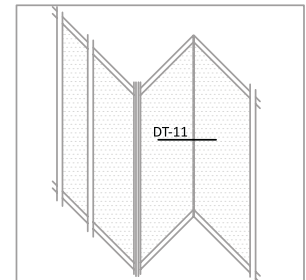

DT-12

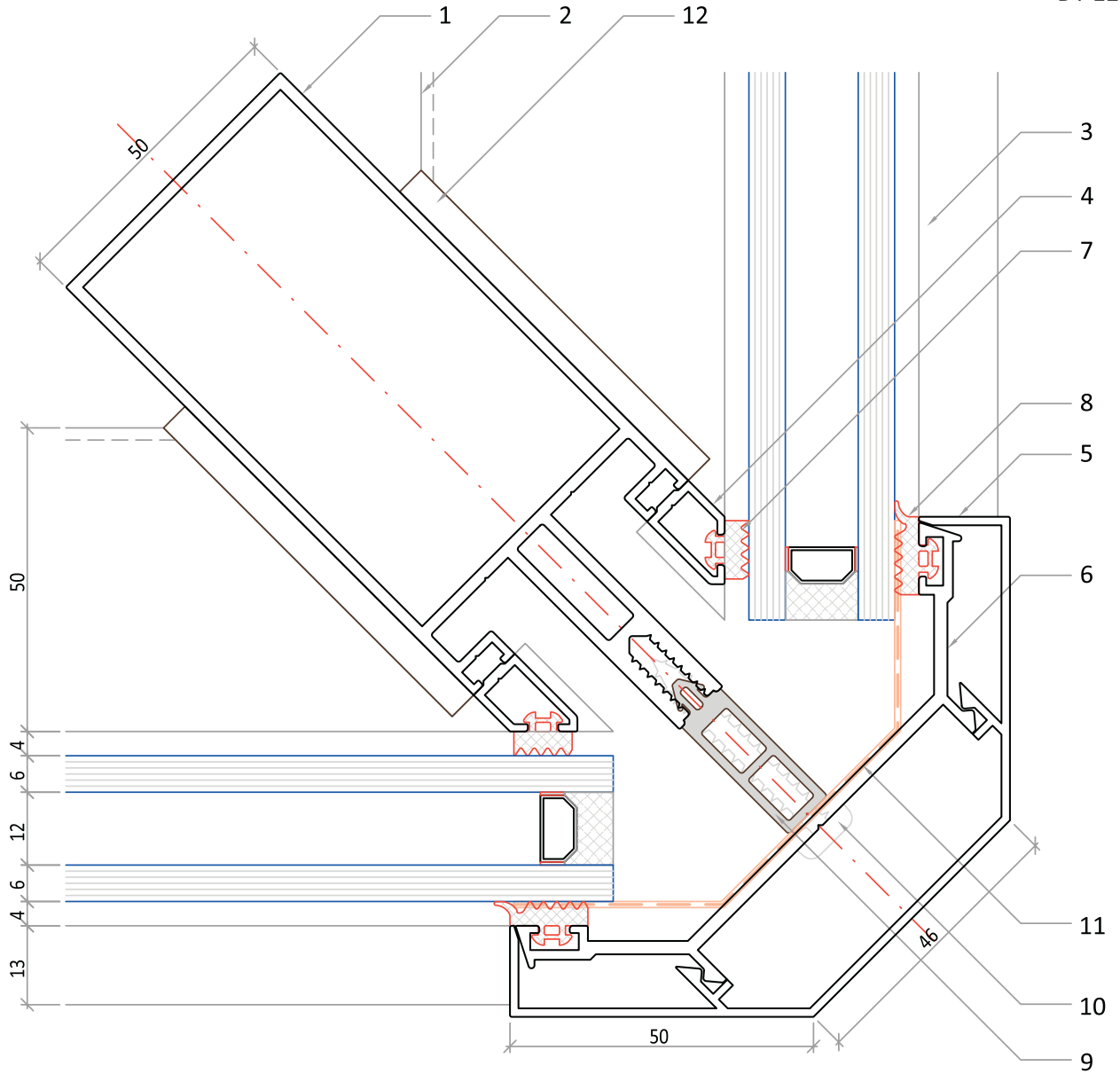

- 1 5016 DÜŞEY PROFİL
- 2 5007 YATAY PROFİL
- 3 5053 YATAY KAPAK PROFİLİ
- 4 5105 İÇ KÖŞE ADAPTÖR PROFİLİ
- 5 5100 DIŞ KÖŞE KAPAK PROFİLİ
- 6 5101 DIŞ KÖŞE ALT KAPAK PROFİLİ
- 7 CF-23 İÇ CAM FİTİLİ
- 8 CF-24 DIŞ CAM FİTİLİ
- 9 CP-4 BOYUN PLASTİĞİ

- 10 5.5 SB VİDA
- 11 SU YALITMI
- 12 YATAY KAYIT CONTASI

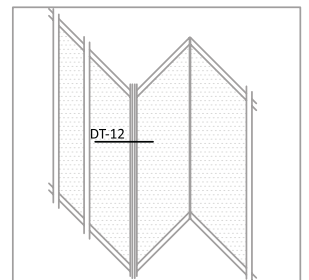

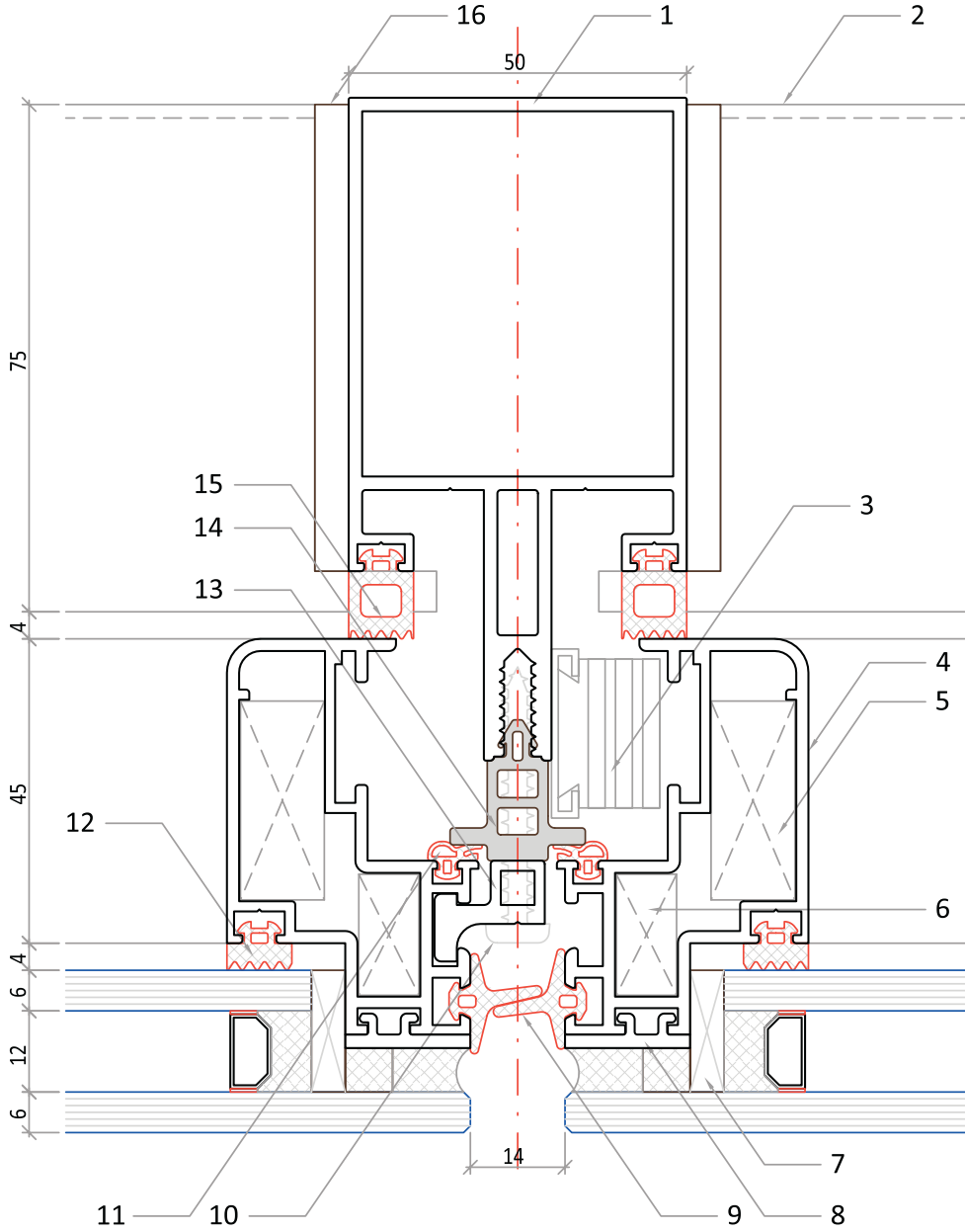

- 1 5015 DÜŞEY PROFİL
- 2 5008 YATAY PROFİL
- 3 MAKAS
- 4 5115 PANO PROFİLİ
- 5 5128 PANO PROFİLİ KÖŞE TAKOZU
- 6 5129 PANO PROFİLİ KÖŞE TAKOZU
- 7 PVC TAKOZ
- 8 5121 CAM YAPIŞTIRMA PROFİLİ

- 9 CF-29 PANO BİNE FİTİLİ
- 10 4.8 SB VİDA
- 11 CF-27 BASKI FİTİLİ
- 12 CF-23 YATAY İÇ CAM FİTİLİ
- 13 5124 MONTAJ PROFİLİ
- 14 CP-5 BOYUN PLASTİĞİ
- 15 CF-20 YATAY İÇ CAM FİTİLİ
- 16 YATAY KAYIT CONTASI

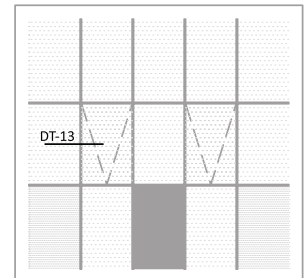

DT-14

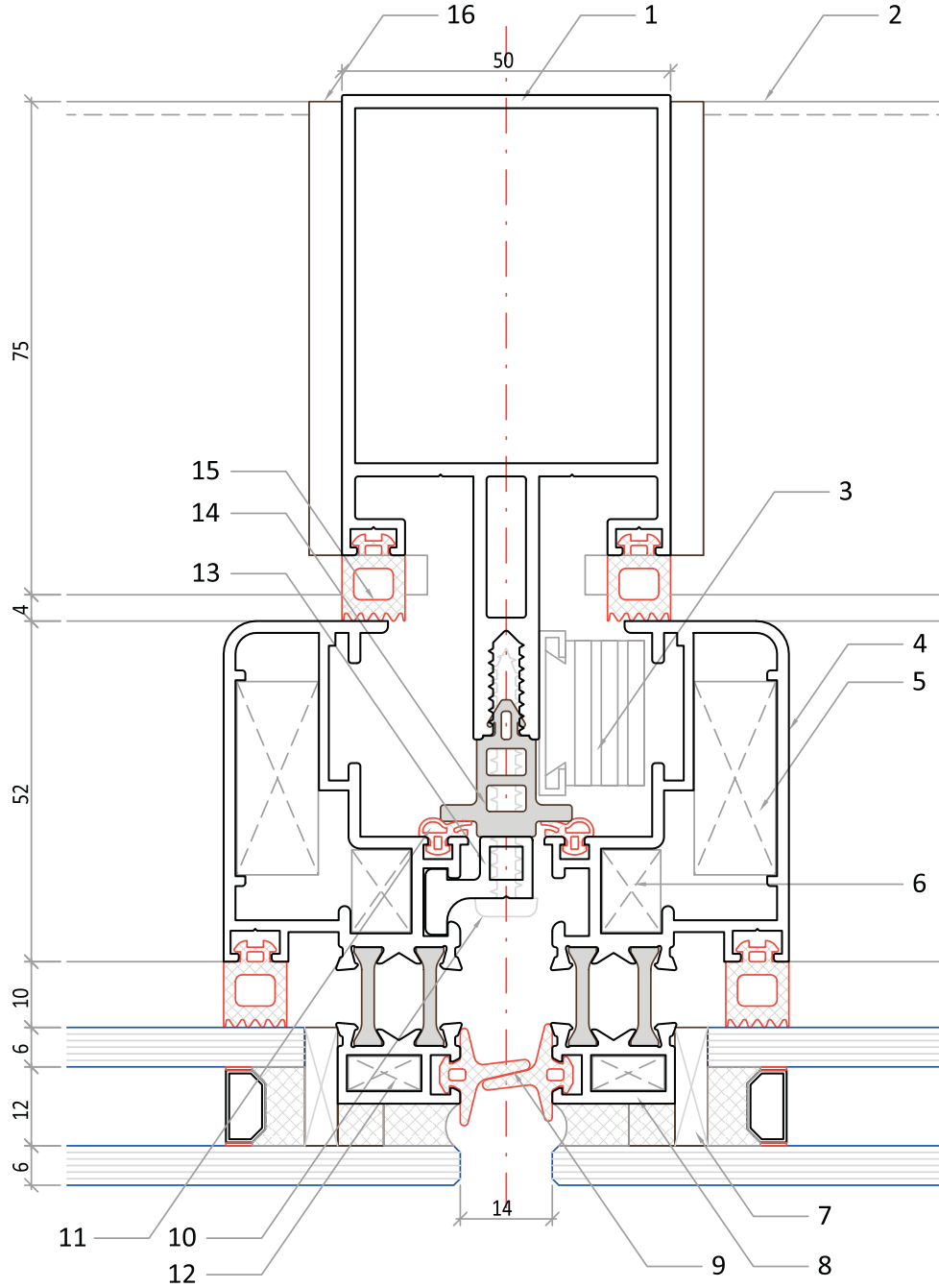

- 1 5015 DÜŞEY PROFİL
- 2 5008 YATAY PROFİL
- 3 MAKAS
- 4 5116 İZOLASYONLU PANO PROFİLİ
- 5 5128 PANO PROFİLİ KÖŞE TAKOZU
- 6 5129 PANO PROFİLİ KÖŞE TAKOZU
- 7 PVC TAKOZ
- 8 5120 CAM YAPIŞTIRMA PROFİLİ

- 9 CF-29 PANO BİNE FİTİLİ
- 10 4.8 SB VİDA
- 11 CF-27 BASKI FİTİLİ
- 12 5130 PANO PROFİLİ KÖŞE TAKOZU
- 13 5124 MONTAJ PROFİLİ
- 14 CP-5 BOYUN PLASTİĞİ
- 15 CF-20 YATAY İÇ CAM FİTİLİ
- 16 YATAY KAYIT CONTASI

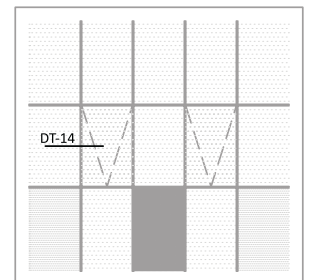

DT-16

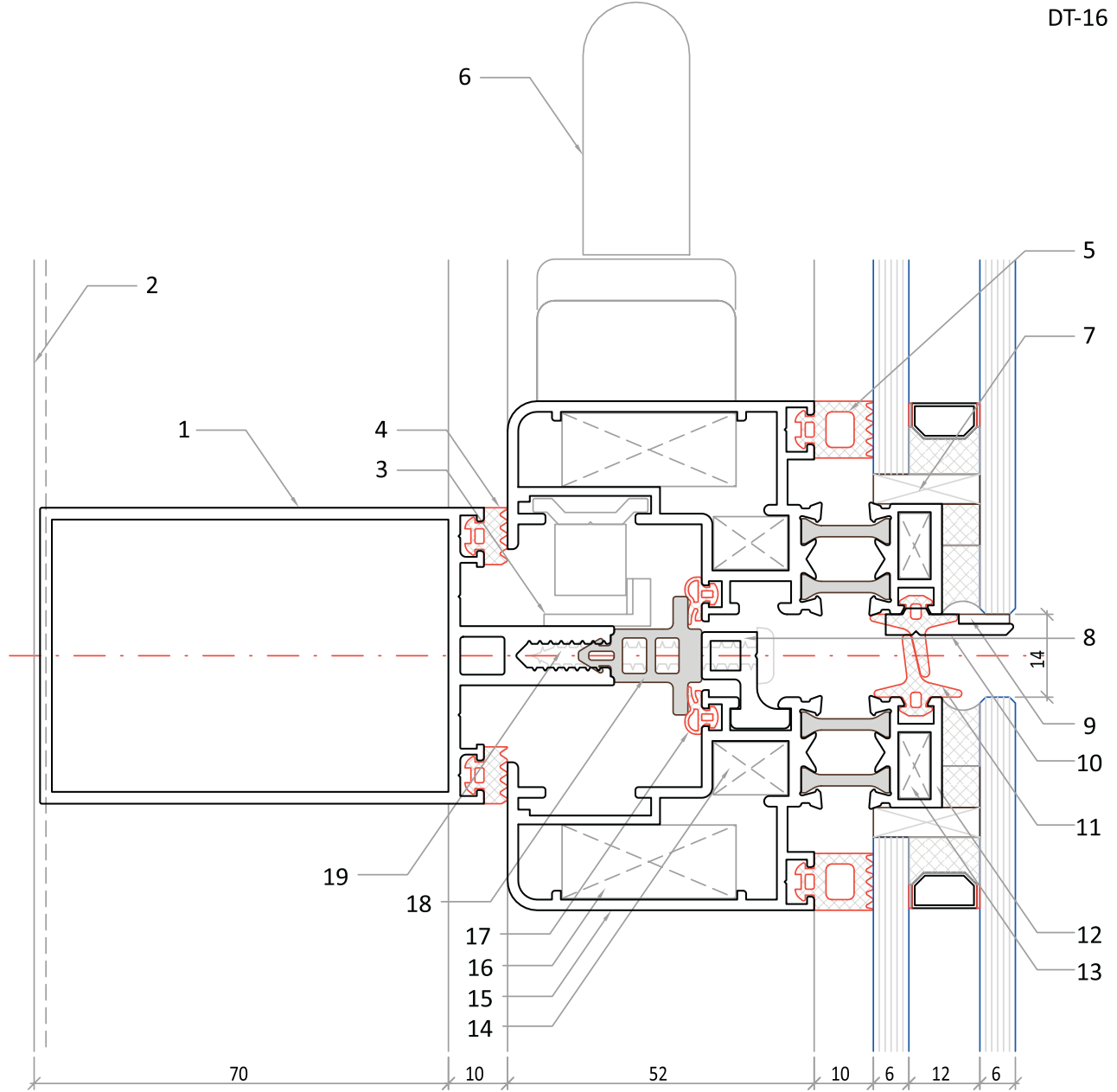

- 1 5008 YATAY PROFİL
- 2 5015 DÜŞEY PROFİL
- 3 KİLİT KARŞILIĞI
- 4 CF-23 YATAY İÇ CAM FİTİLİ
- 5 CF-20 YATAY İÇ CAM FİTİLİ
- 6 KOL
- 7 PVC TAKOZ
- 8 5124 MONTAJ PROFİLİ
- 9 PVC TAKOZ

- 10 5123 CAM TAKOZU
- 11 CF-29 PANO BİNİ FİTİLİ
- 12 5120 CAM YAPIŞTIRMA PROFİLİ
- 13 5130 PANO PROFİLİ KÖŞE TAKOZU
- 14 5129 PANO PROFİLİ KÖŞE TAKOZU
- 15 5116 İZOLASYONLU PANO PROFİLİ
- 16 5128 PANO PROFİLİ KÖŞE TAKOZU
- 17 CF-27 BASKI FİTİLİ
- 18 CP-5 BOYUN PLASTİĞİ
- 19 4.8 SB VİDA

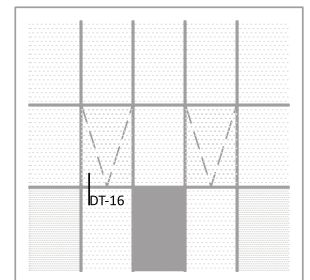

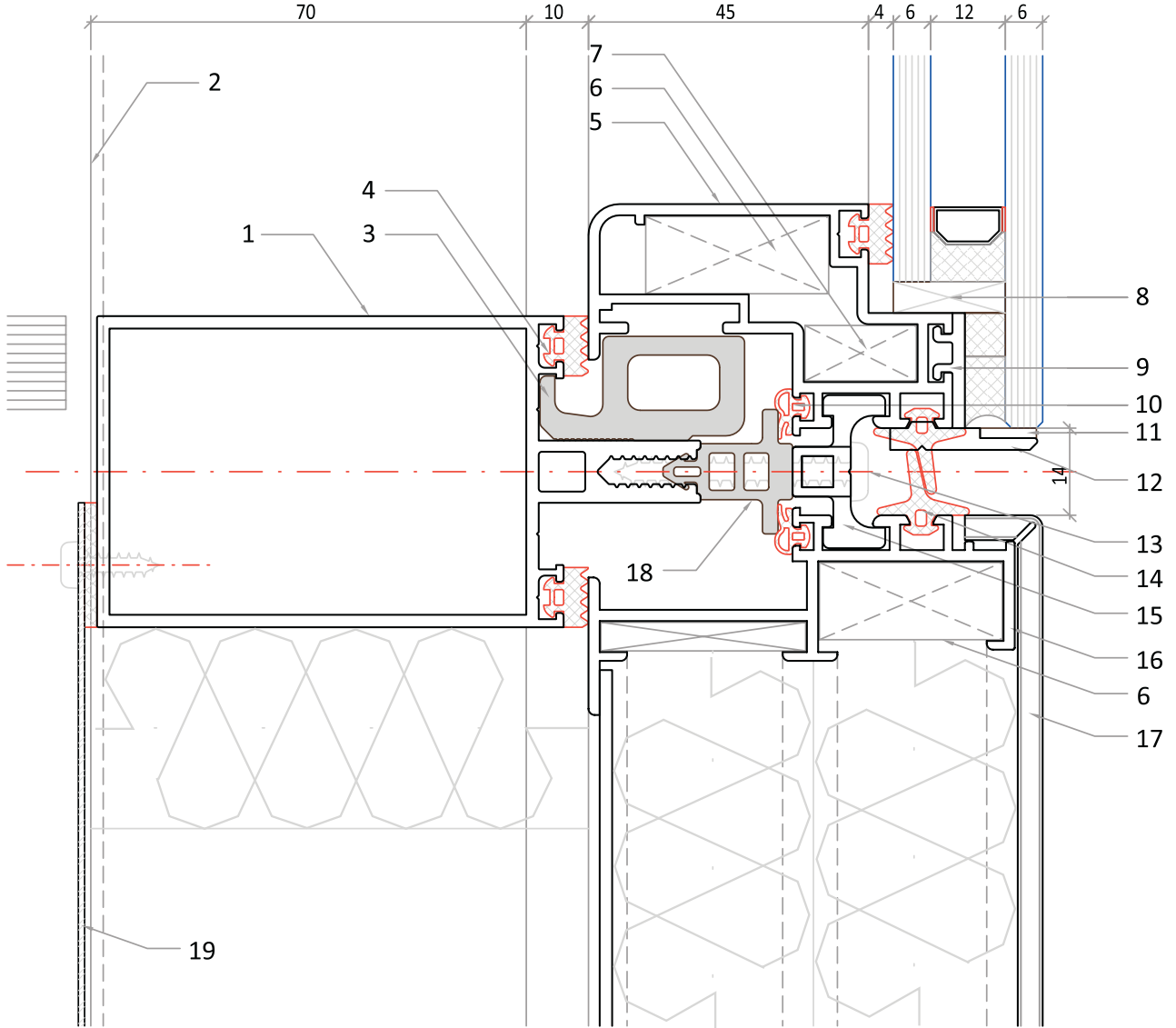

- 1 5008 YATAY PROFİL
- 2 5015 DÜŞEY PROFİL
- 3 CP-6 PVC TAKOZ
- 4 CF-23 YATAY İÇ CAM FİTİLİ
- 5 5115 PANO PROFİLİ
- 6 5128 PANO PROFİLİ KÖŞE TAKOZU
- 7 5129 PANO PROFİLİ KÖŞE TAKOZU
- 8 PVC TAKOZ
- 9 5121 CAM YAPIŞTIRMA PROFİLİ

- 10 CF-27 BASKI FİTİLİ
- 11 PVC TAKOZ
- 12 5122 CAM TAKOZU
- 13 4.8 SB VİDA
- 14 CF-29 PANO BİNE FİTİLİ
- 15 5124 MONTAJ PROFİLİ
- 16 5119 KOMPOZE PANO PROFİLİ
- 17 KOMPOZE LEVHA
- 18 CP-5 BOYUN PLASTİĞİ
- 19 1 mm GALVANİZ LEVHA

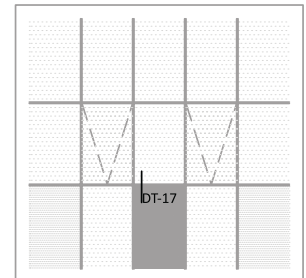

DT-18

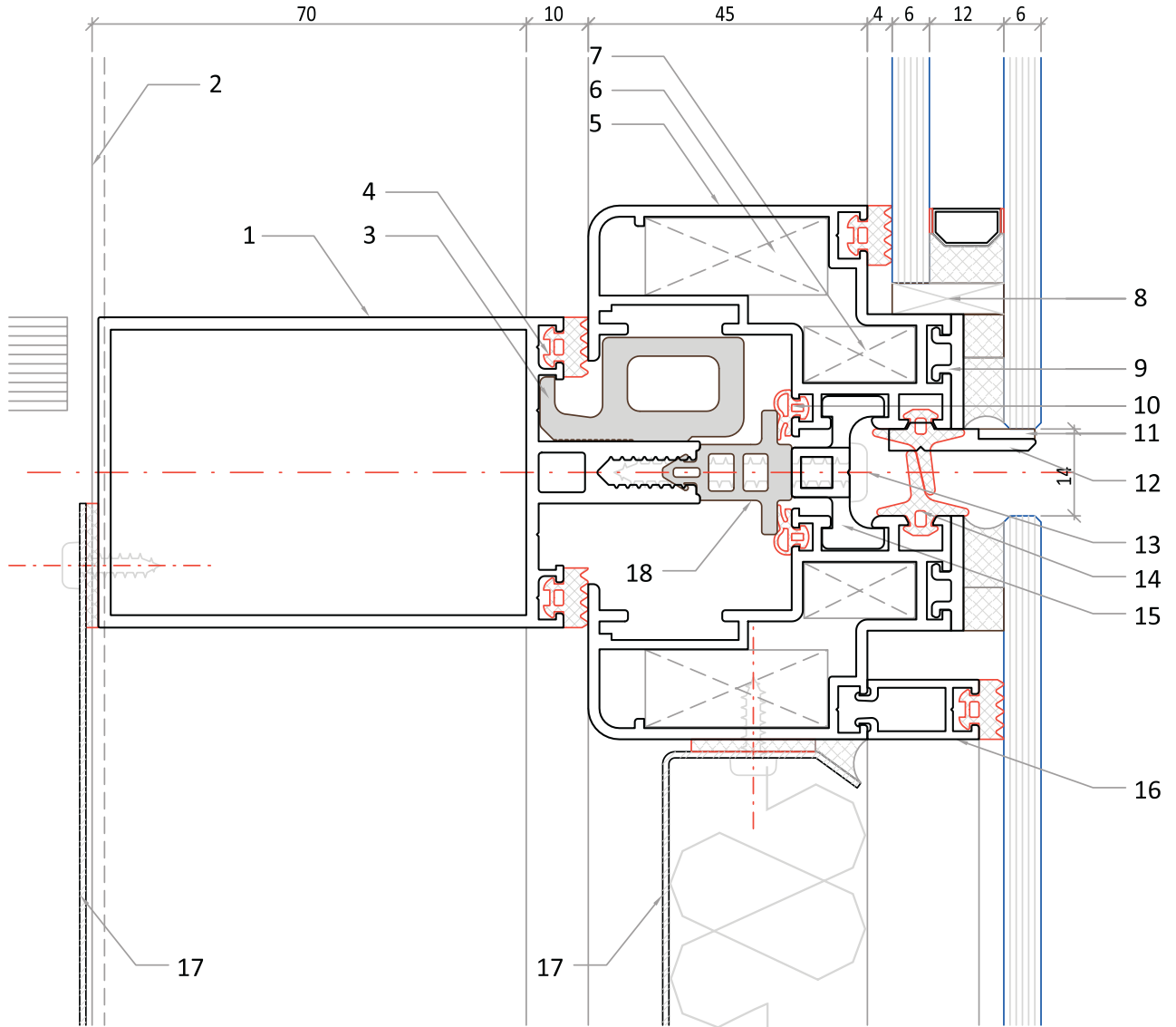

- 1 5008 YATAY PROFİL
- 2 5015 DÜŞEY PROFİL
- 3 CP-6 PVC TAKOZ
- 4 CF-23 YATAY İÇ CAM FİTİLİ
- 5 5115 PANO PROFİLİ
- 6 5128 PANO PROFİLİ KÖŞE TAKOZU
- 7 5129 PANO PROFİLİ KÖŞE TAKOZU
- 8 PVC TAKOZ
- 9 5121 CAM YAPIŞTIRMA PROFİLİ

- 10 CF-27 BASKI FİTİLİ
- 11 PVC TAKOZ
- 12 5122 CAM TAKOZU
- 13 4.8 SB VİDA
- 14 CF-29 PANO BİNİ FİTİLİ
- 15 5124 MONTAJ PROFİLİ
- 16 5107 CAM YUVASI KÜÇÜLTME PROFİLLERİ
- 17 KOMPOZE LEVHA
- 18 CP-5 BOYUN PLASTİĞİ
- 19 1 mm GALVANİZ LEVHA

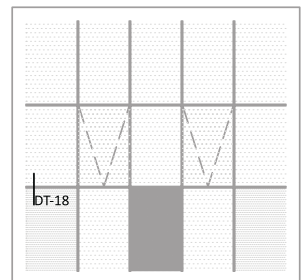

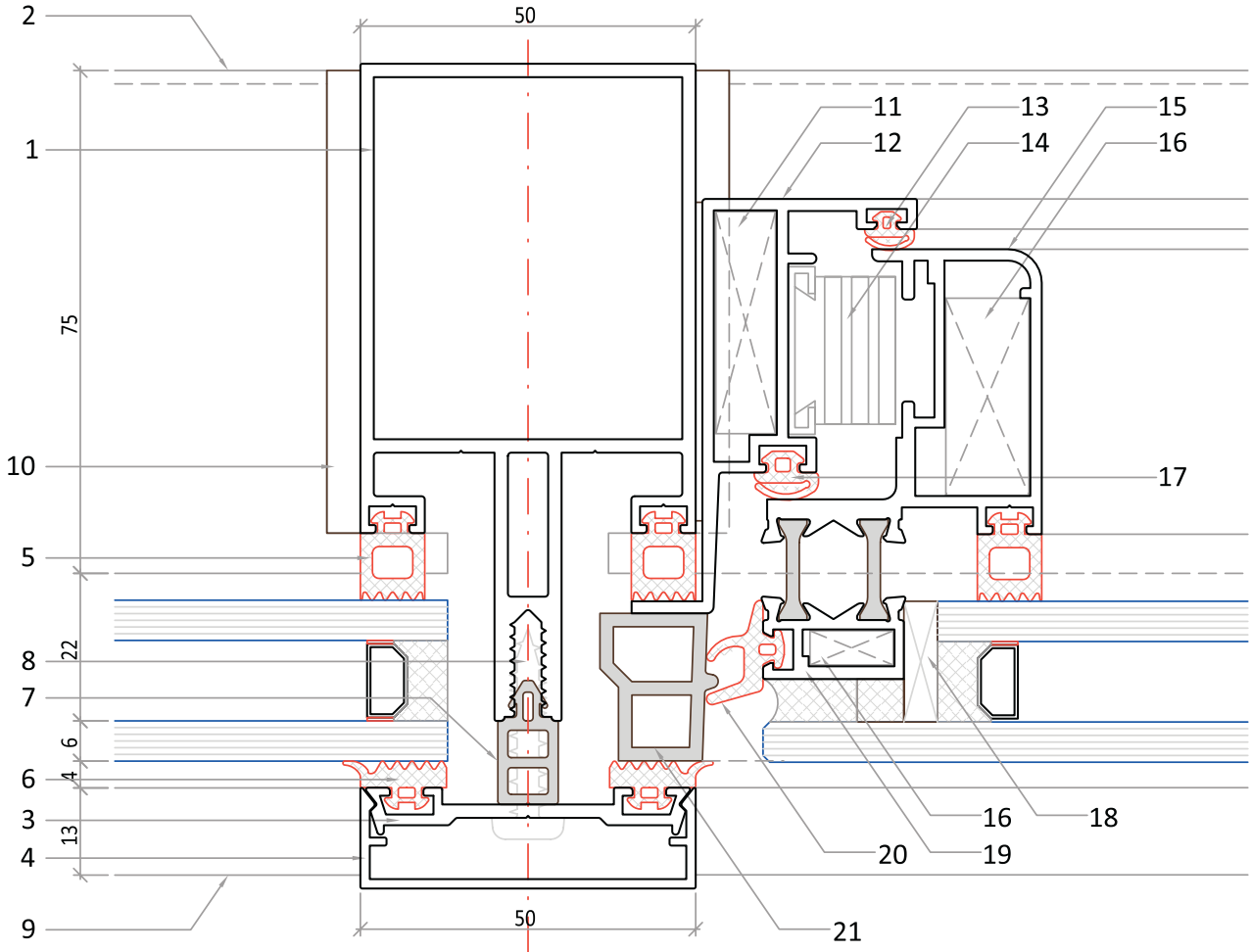

- 1 5015 DÜŞEY PROFİL
- 2 5008 YATAY PROFİL
- 3 5054 ALT KAPAK PROFİLİ
- 4 5052 DÜŞEY KAPAK PROFİLİ
- 5 CF-20 İÇ CAM FİTİLİ
- 6 CF-24 DIŞ CAM FİTİLİ
- 7 CP-1 BOYUN PLASTİĞİ
- 8 5.5 SB VİDA
- 9 5053 YATAY KAPAK PROFİLİ
- 10 YATAY KAYIT CONTASI

- 11 5129 PANO PROFİLİ KÖŞE TAKOZU
- 12 5118 CEPHE İÇİ KANAT KASA PROFİLİ
- 13 CF-25 KANAT İÇ BASKI FİTİLİ
- 14 MAKAS
- 15 5117 CEPHE İÇİ KANAT PROFİLİ
- 16 5128 PANO PROFİLİ KÖŞE TAKOZU
- 17 CF-26 KANAT DIŞ BASKI FİTİLİ
- 18 PVC TAKOZ
- 19 5131 CEPHE İÇİ KANAT CAM YAPIŞTIRMA PROF.
- 20 CF-28 KANAT BİNİ FİTİLİ
- 21 CP-7 PVC TAKOZ

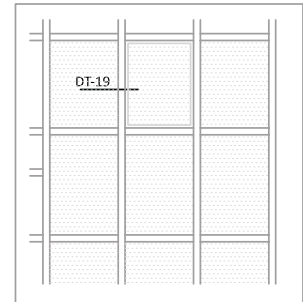

DT-20

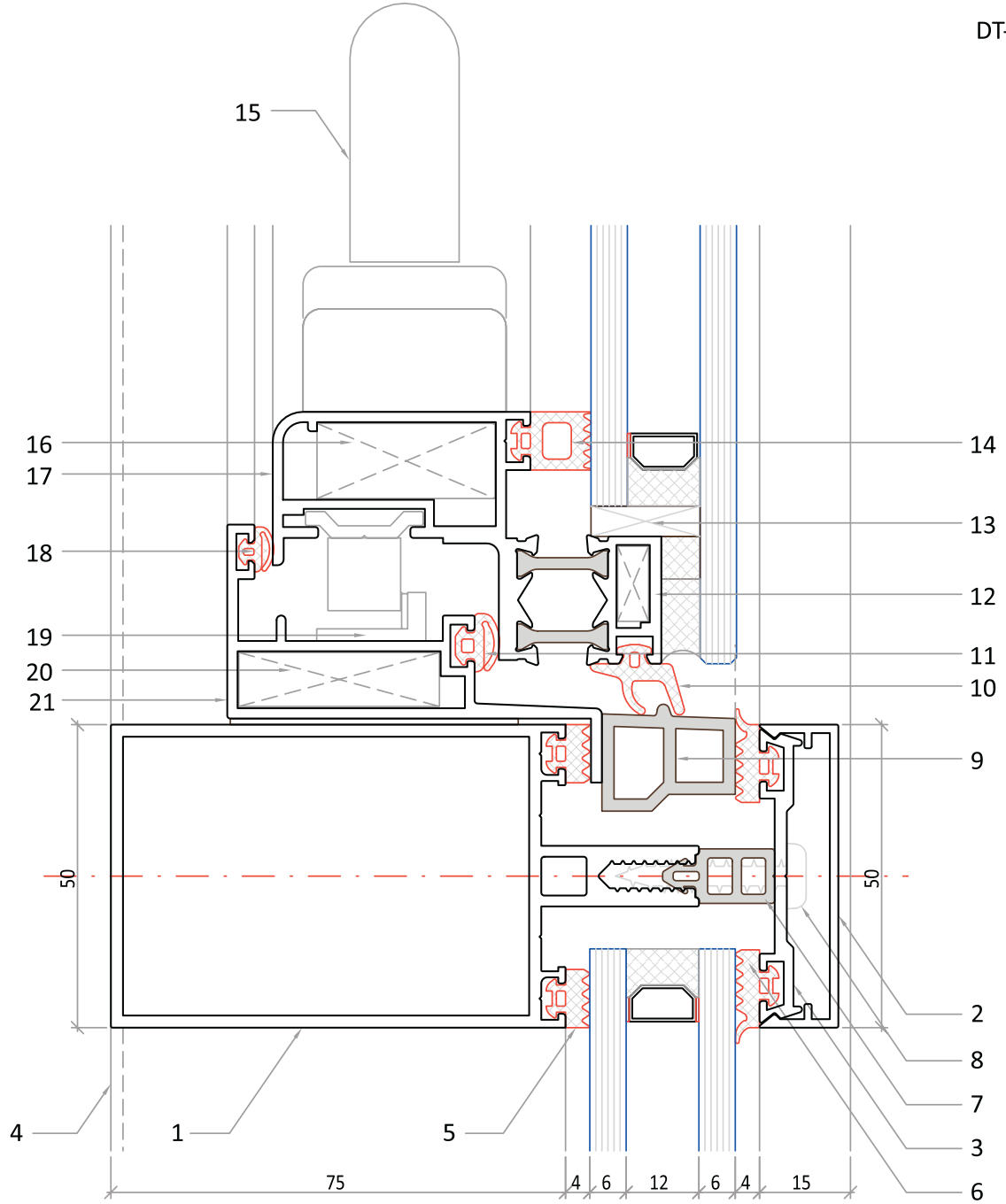

- 1 5008 YATAY PROFİL
- 2 5053 YATAY KAPAK PROFİLİ
- 3 5054 ALT KAPAK PROFİLİ
- 4 5008 YATAY PROFİL
- 5 CF-23 İÇ CAM FİTİLİ
- 6 CF-24 DIŞ CAM FİTİLİ
- 7 CP-1 BOYUN PLASTİĞİ
- 8 5.5 SB VİDA
- 9 CP-7 PVC TAKOZ
- 10 CF-28 KANAT BİNİ FİTİLİ
- 11 CF-26 KANAT DIŞ BASKI FİTİLİ

- 12 5131 CEPHE İÇİ KANAT CAM YAPIŞTIRMA PROF.
- 13 PVC TAKOZ
- 14 CF-20 YATAY İÇ CAM FİTİLİ
- 15 KOL
- 16 5128 PANO PROFİLİ KÖŞE TAKOZU
- 17 5117 CEPHE İÇİ KANAT PROFİLİ
- 18 CF-25 KANAT İÇ BASKI FİTİLİ
- 19 KİLİT KARŞILIĞI
- 20 5129 PANO PROFİLİ KÖŞE TAKOZU
- 21 5118 CEPHE İÇİ KANAT KASA PROFİLİ

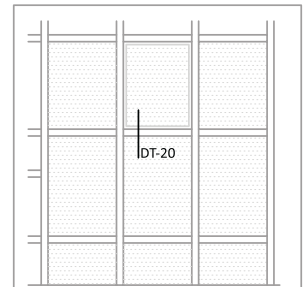

SBF 50 PROFİLLER - AKSESUARLAR

STARKBAU
ALÜMİNYUM PROFİL SİSTEMLERİ

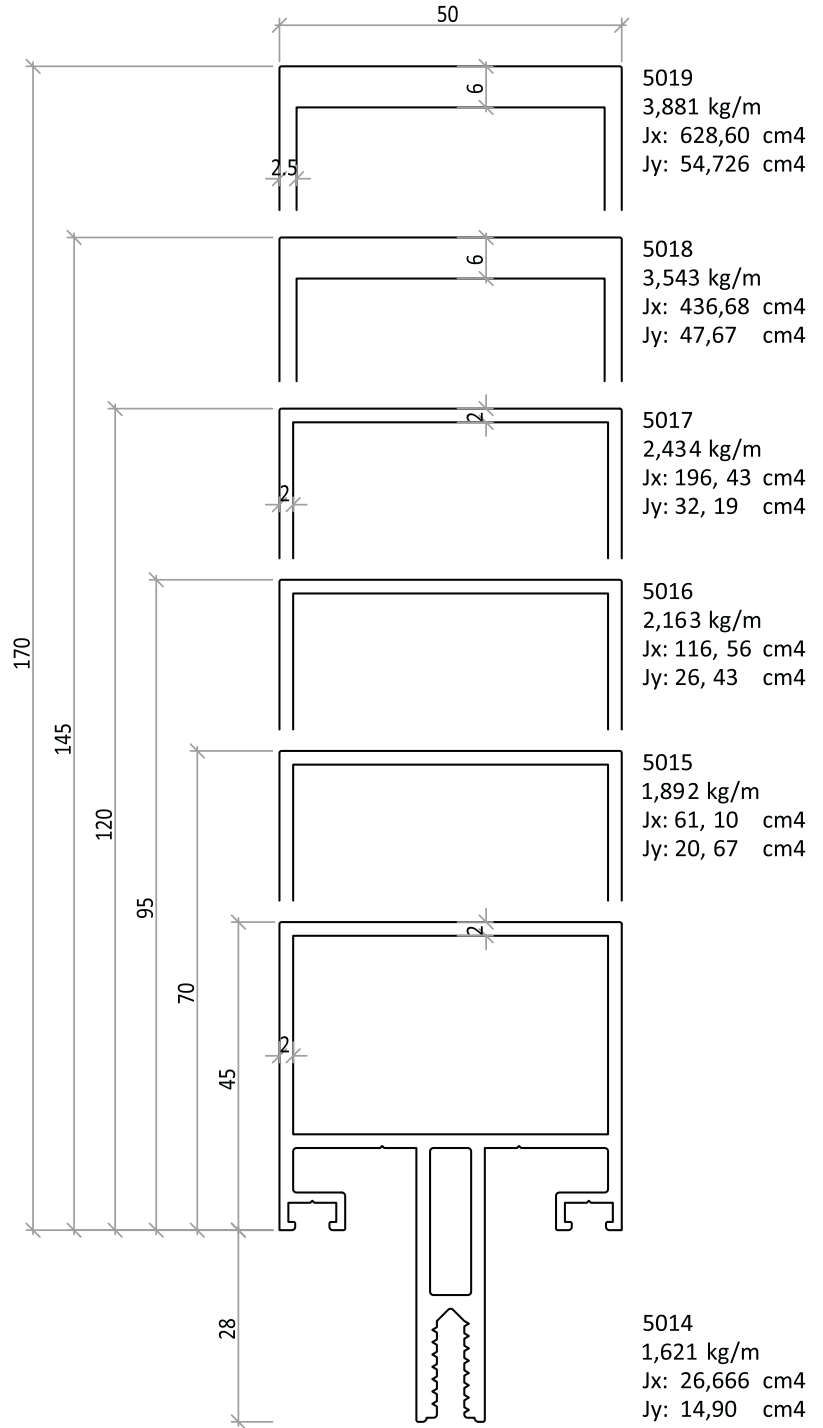
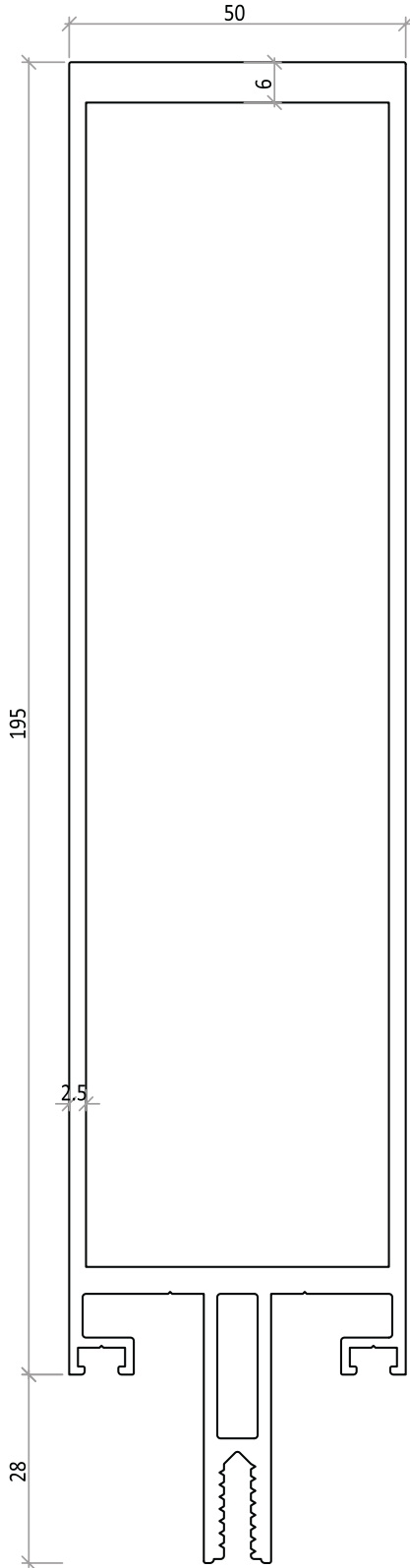

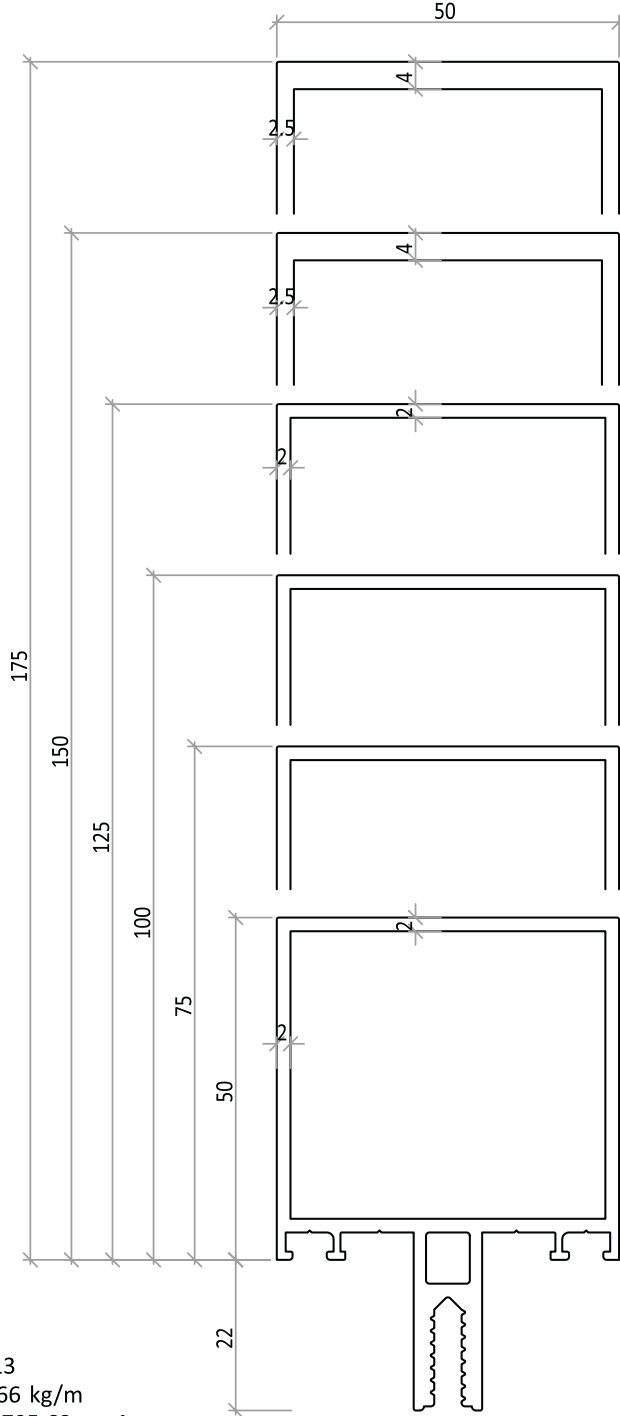
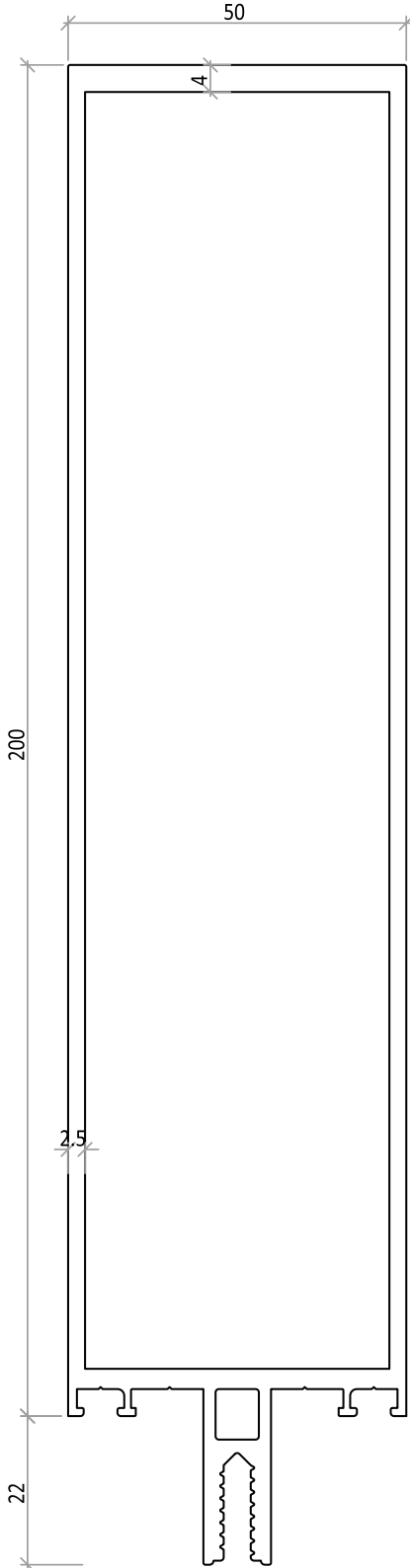

5012
3,505 kg/m
Jx: 552,49 cm⁴
Jy: 54,07 cm⁴

5011
3,166 kg/m
Jx: 383,85 cm⁴
Jy: 47,01 cm⁴

5010
2,266 kg/m
Jx: 195,57 cm⁴
Jy: 32,38 cm⁴

5009
1,996 kg/m
Jx: 117,64 cm⁴
Jy: 26,62 cm⁴

5008
1,725 kg/m
Jx: 62,57 cm⁴
Jy: 20,86 cm⁴

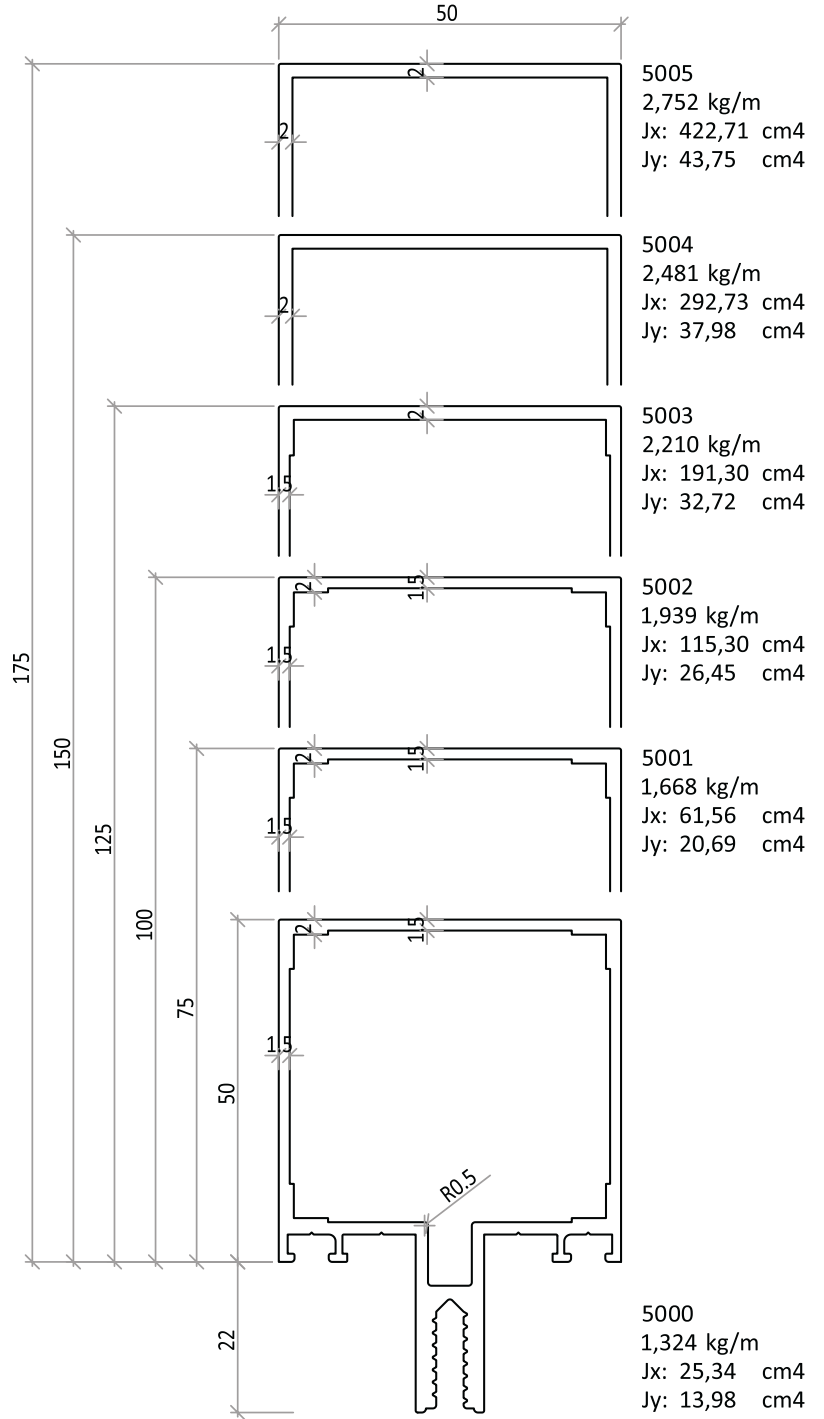
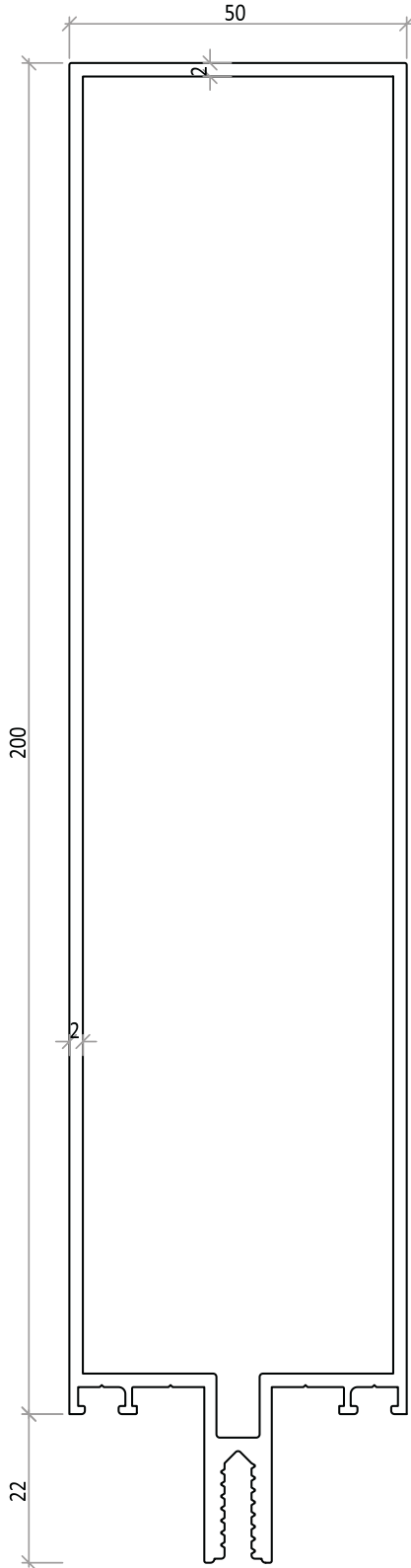

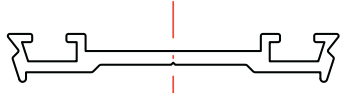

ALT KAPAK PROFİLİ
5054
0,326 kg/m

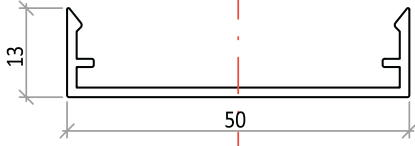

KAPAK PROFİLİ
5053
0,294 kg/m

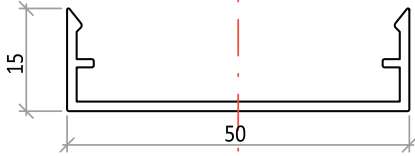

KAPAK PROFİLİ
5052
0,309 kg/m

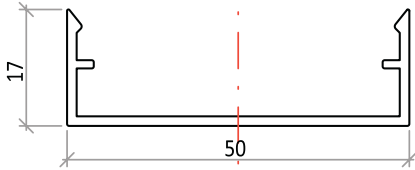

KAPAK PROFİLİ
5051
0,324 kg/m

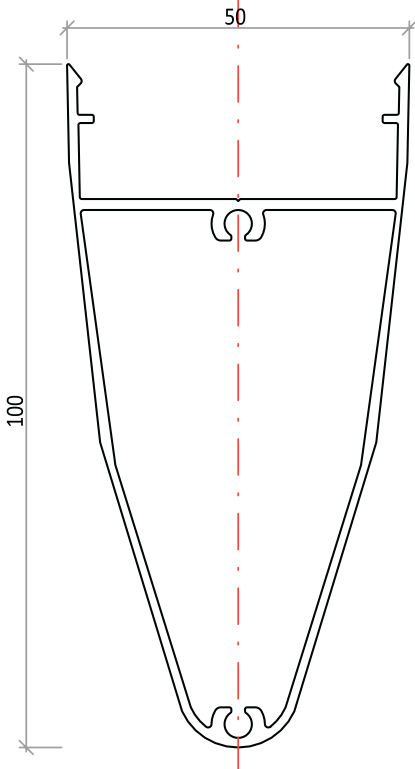

KAPAK PROFİLİ
5050
1,143 kg/m

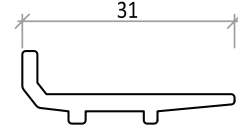

CAM TAKOZU PROFİLİ
5055
0,240 kg/m
(Cam Kalınlığı 24mm'e Kadar)

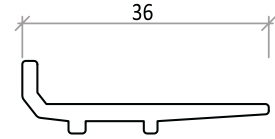

CAM TAKOZU PROFİLİ
5056
0,267 kg/m
(Cam Kalınlığı 32mm'e Kadar)



İÇ KÖŞE ADAPTÖR
5105
0,132 kg/m

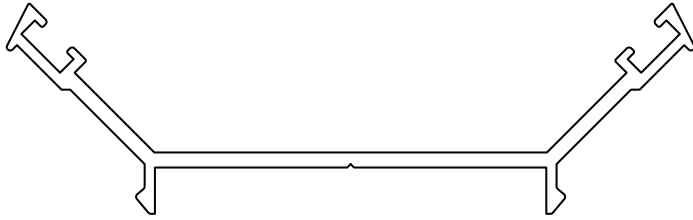

DIŞ KÖŞE ALT KAPAK
5101
0,825 kg/m

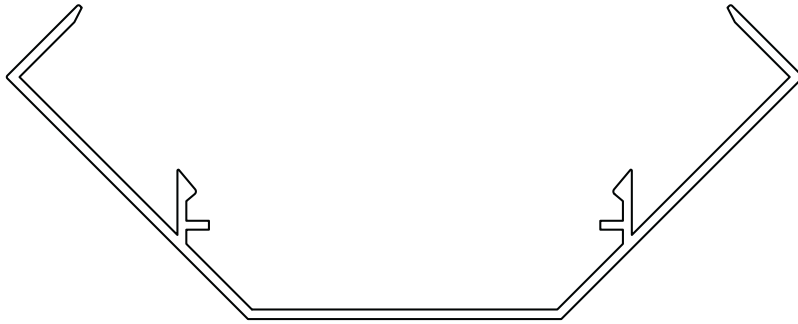

DIŞ KÖŞE KAPAK
5100
0,752 kg/m

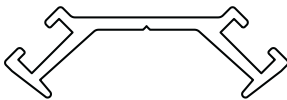

İÇ KÖŞE ALT KAPAK
5103
0,317 kg/m

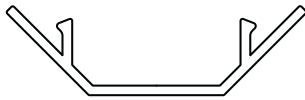

İÇ KÖŞE KAPAK
5102
0,250 kg/m

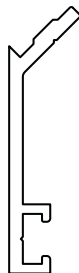

İÇ KÖŞE ADAPTÖR
5104
0,278 kg/m

CAM YUVASI KÜÇÜLTME PROFİLLERİ

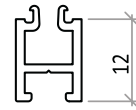

5106
0,138 kg/m

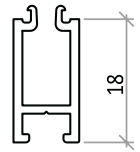

5107
0,180 kg/m

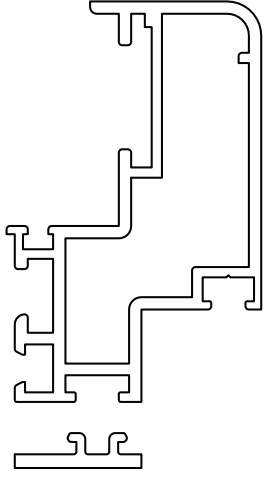

PANO PROFİLİ
5115
1,023 kg/m
Jx: 14,14 cm⁴
Jy: 3,33 cm⁴
(Siyah Eloksal)

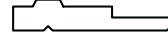

CAM TAKOZU
5122
0,192 kg/m



CAM TAKOZU
5123
0,172 kg/m

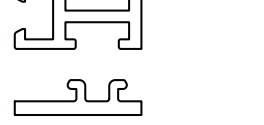

CAM YAPIŞTIRMA PROFİLİ
5121
0,130 kg/m
(Siyah Eloksal)

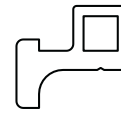

MONTAJ PROFİLİ
5124
0,268 kg/m

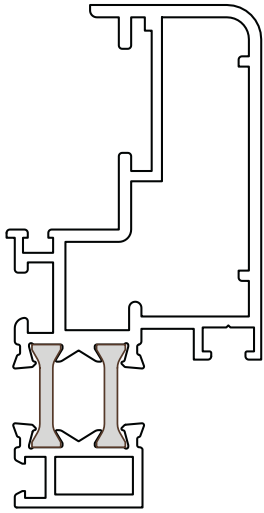

İZOLASYONLU
PANO PROFİLİ
5116
1,289 kg/m
Jx: 24,915 cm⁴
Jy: 4,34 cm⁴
(Siyah Eloksal)

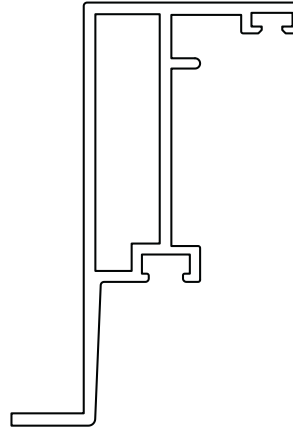

CEPHE İÇİ KANAT
KASA PROFİLİ
5118
0,797 kg/m
Jx: 12,57 cm⁴
Jy: 1,38 cm⁴

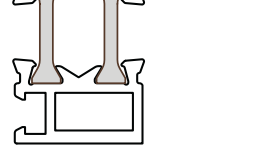

CAM YAPIŞTIRMA
PROFİLİ
5120
0,279 kg/m
(Siyah Eloksal)

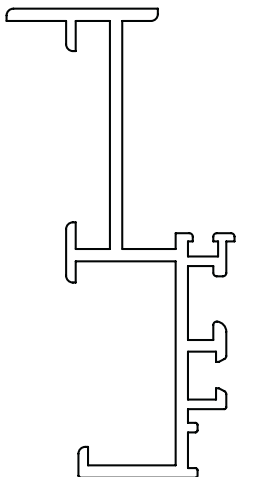

KOMPOZE
PANO PROFİLİ
5119
0,770 kg/m
Jx: 14,35 cm⁴
Jy: 1,07 cm⁴

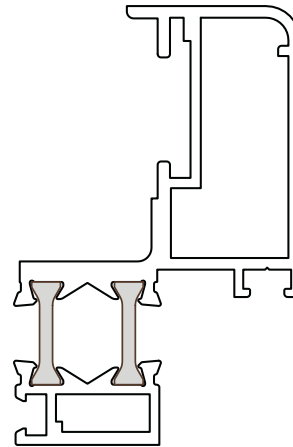

CEPHE İÇİ KANAT
5117
1,200 kg/m
Jx: 19,90 cm⁴
Jy: 3,68 cm⁴
(Siyah Eloksal)

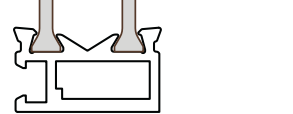

CEPHE İÇİ KANAT
CAM YAPIŞTIRMA PROFİLİ
5131
0,302 kg/m
(Siyah Eloksal)



BAĞLANTI PROFİLİ
5127
0,467 kg/m

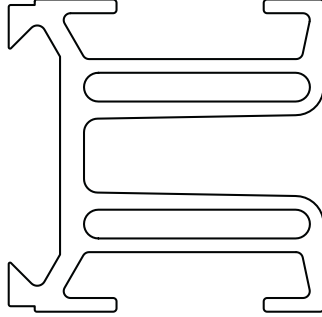

BAĞLANTI PROFİLİ
5126
1,672 kg/m

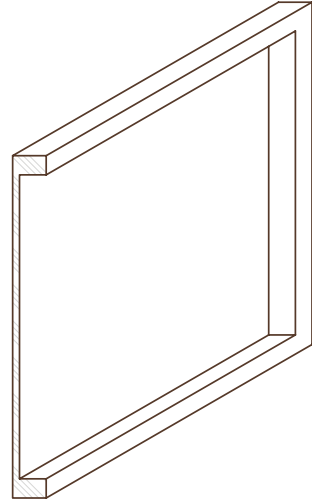

YATAY BAĞLANTI
PLASTİĞİ
CP-8

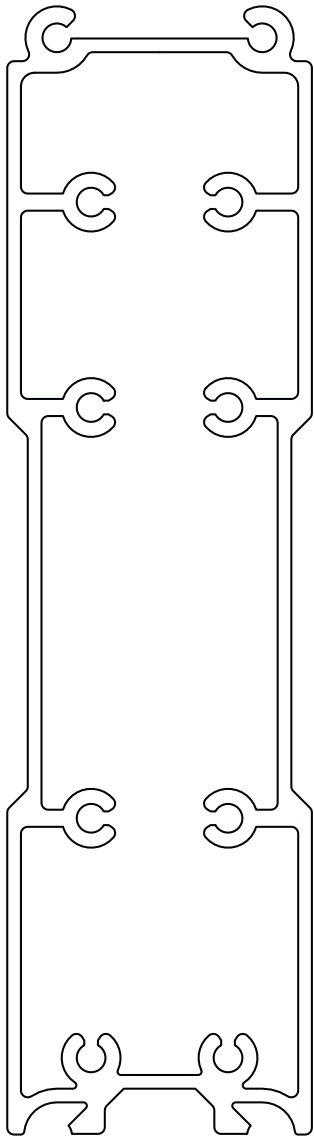

DİLATASYON PROFİLİ
5125
3,601 kg/m
(Kesim Boyu 200mm)

YATAY BAĞLANTI PROFİLLERİ KESİM ÖLÇÜLERİ:

KALIP NO	KULLANIM YERİ	KESİM BOYU
5126	5007	41.6 mm
5127	5008	66.6 mm
	5009	91.6 mm
	5010	116.6 mm
	5000	41.6 mm
	5001	66.6 mm
	5002	91.6 mm
	5003	116.6 mm

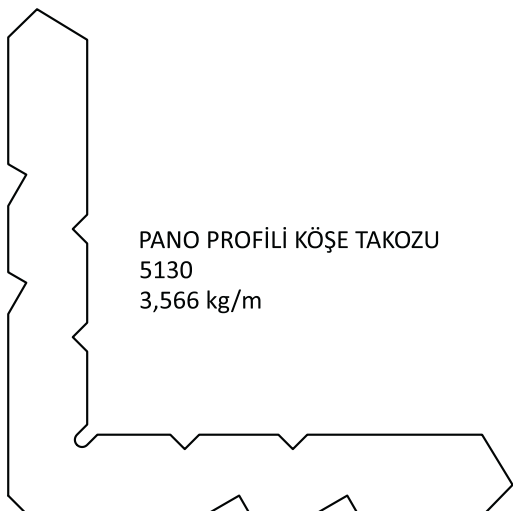
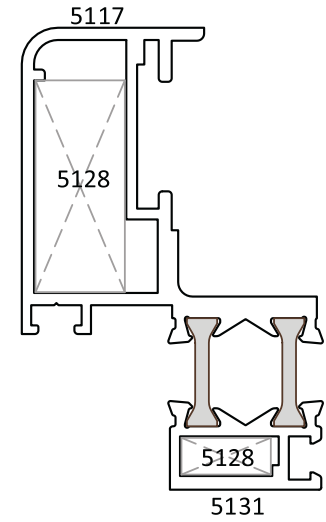
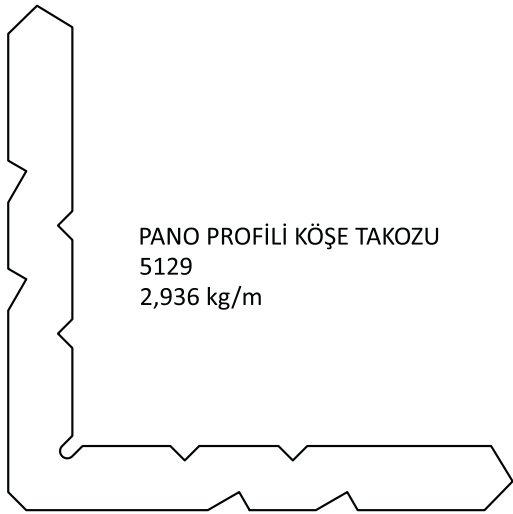
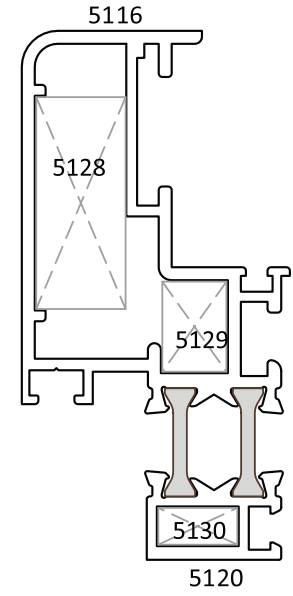
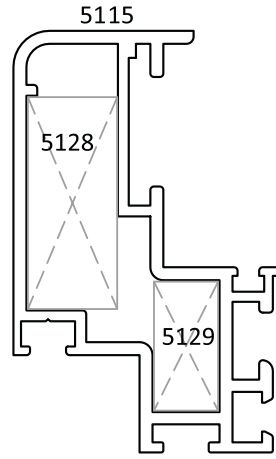
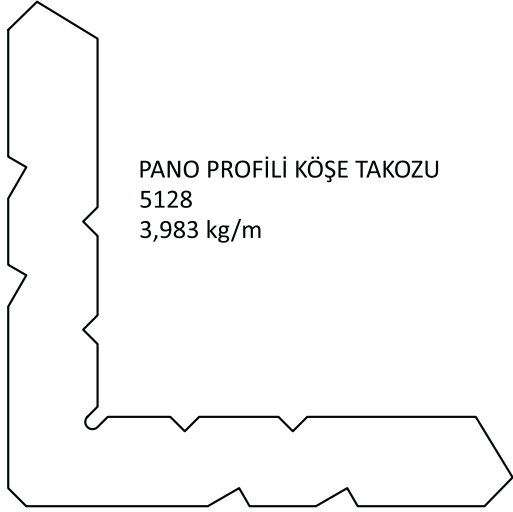

KALIP NO	KULLANIM YERİ	KESİM BOYU
5128	5115	29.5 mm
5128	5116	29.5 mm
5128	5117	29.5 mm
5128	5131	5 mm
5129	5115	18 mm
5129	5116	12.5 mm
5130	5120	5 mm

CAM FITİLLERİ

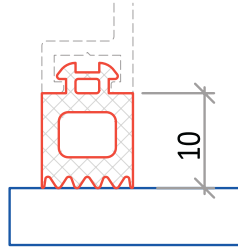

CF-20

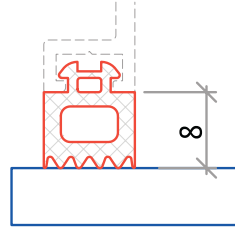

CF-21



CF-25



CF-26

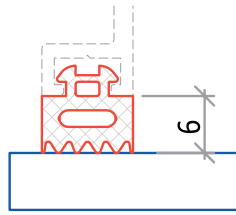

CF-22

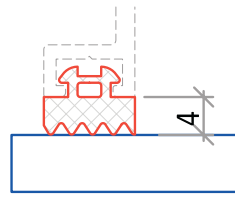

CF-23



CF-27

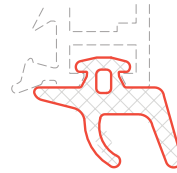

CF-28

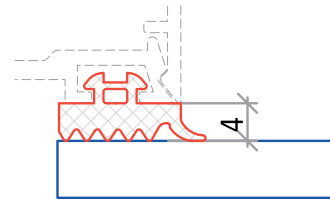

CF-24

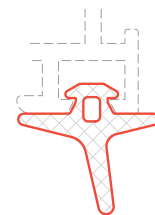

CF-29

KALIP NO	PAKET BİLGİSİ
CF-20	300 MT / KOLI
CF-21	300 MT / KOLI
CF-22	300 MT / KOLI
CF-23	300 MT / KOLI
CF-24	300 MT / KOLI
CF-25	300 MT / KOLI
CF-26	300 MT / KOLI
CF-27	300 MT / KOLI
CF-28	300 MT / KOLI
CF-29	300 MT / KOLI

BOYUN PLASTİKLERİ

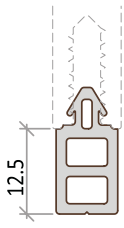

CP- 1

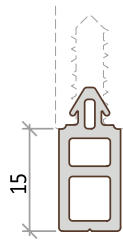

CP- 2

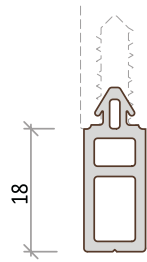

CP-3

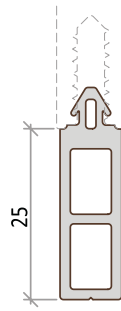

CP- 4

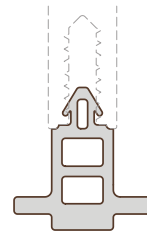

CP- 5

PLASTİK AKSESUARLAR

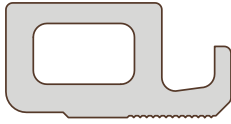

CP-6

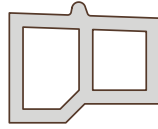

CP-7



CP-8

KALIP NO	PAKET BİLGİSİ
CP-1	100 ADET / KUTU
CP-2	100 ADET / KUTU
CP-3	100 ADET / KUTU
CP-4	100 ADET / KUTU
CP-5	100 ADET / KUTU
CP-6	100 ADET / KUTU
CP-7	100 ADET / KUTU
CP-8	100 ADET / KUTU